**Technical Support:**

Email: [customerservice@carmanah.com](mailto:customerservice@carmanah.com)  
Toll Free: 1.877.722.8877 (US & Canada)  
Worldwide: 1.250.380.0052  
Fax: 1.250.380.0062  
Web: [carmanah.com](http://carmanah.com)

## Warnings & Precautions

The following symbols indicate important safety warnings and precautions throughout this manual. They are defined as follows:



WARNING indicates that serious bodily harm or death may result from failure to adhere to the precautions.



CAUTION indicates that damage to equipment may result if the instructions are not followed.



NOTE suggests optimal conditions under which the equipment will operate effectively and safely, or provides additional information to the reader.

## Regulatory Information

This Class [B] digital apparatus complies with Canadian ICES-003.

Cet appareil numérique de la classe [B] est conforme à la norme NMB-003 du Canada.



Changes or modifications not expressly approved by the party responsible for compliance could void the user's authority to operate the equipment. Installation work must be done by a qualified person(s) in accordance with all applicable local codes and standards.

Equipment shall be positioned outside the 5m vicinity of a compass as per ISO 694.



## Safety and Usage Precautions



The lantern's Battery Pack contains lead, lead compounds, and other compounds known to the State of California to cause cancer and reproductive harm. Please handle with care and wash your hands thoroughly after handling the Battery Pack.



Charge your lantern's Battery Pack periodically. Permanent damage and reduced capacity will result if the Battery Pack is not correctly maintained. Refer to page 21 for details.

Lanterns that have been stored may require a top-up charge before they are put into service. The most accurate Battery Pack status reading is obtained when the lantern has been in a dark location and in Off mode for at least 24 hours.

## Warranty Disclaimer

NOTE

This manual will familiarize you with the features and operation standards of Carmanah's 800 Series lantern. Failure to comply with the use, storage, maintenance, installation or placement instructions detailed in this manual could void the applicable user warranty.

## Table of Contents

Warnings & Precautions.....	2	<b>Installing a Lantern .....</b>	<b>19</b>
Regulatory Information.....	2	Choosing a Suitable Location.....	19
Safety and Usage Precautions.....	2	Adequate Sunlight.....	19
Warranty Disclaimer.....	2	Ambient Temperature .....	19
Table of Contents .....	3	Securing the Lantern .....	19
<b>Introduction.....</b>	<b>4</b>	Installing the Bird Deterrent.....	20
Applications .....	4	<b>Charging the Lantern .....</b>	<b>21</b>
Range.....	4	Sunlight .....	21
Common Features and Functionality .....	4	External Power Source .....	21
<b>Parts Description .....</b>	<b>5</b>	Charge Indicator.....	21
<b>Programming the Lantern .....</b>	<b>6</b>	Charging via an External Power Source (Quick Access Charge Port).....	21
Preparing the Lantern for Installation .....	6	Determining Battery State of Charge .....	22
Viewing Lantern Settings.....	6	Changing the Battery.....	23
Summary of Lantern States and Statuses .....	7	<b>Preparing the Lantern for Storage .....</b>	<b>25</b>
Using the Infrared (IR) Programmer.....	10	Storage Maintenance/Duration.....	25
Turning the Lantern On or Off.....	11	<b>Warranty and Customer Service .....</b>	<b>26</b>
Setting the Flash Character.....	11	Warranty.....	26
Setting Effective Intensity.....	12	Additional Products.....	26
Setting an Intensity to Comply with Obstruction Lighting Standards.....	12	Customer Service .....	26
For all other applications:.....	12	Appendix A: Flash Characters.....	27
Activating/De-activating		Appendix B: Troubleshooting .....	36
Automatic Light Control (ALC) .....	13		
Setting the Calendar Function.....	13		
To toggle the Calendar setting on or off: .....	13		
To set the date that the lantern will enter dated shutdown:.....	13		
To set the date the lantern will reactivate: .....	14		
Editing the Lantern Date and Time (Non-GPS Units Only) .....	15		
To edit the lantern date: .....	15		
To edit the lantern time: .....	15		
Setting Day-to-Night Transition Level .....	16		
Setting Night-to-Day Transition Level .....	16		
Enable/Disable Tap-to-Activate LED Display Option.....	17		
Viewing Firmware Version.....	17		
Setting the GPS Synchronization Function (GPS-equipped Lanterns Only).....	18		
GPS Status (GPS-equipped Lanterns Only) .....	18		

## Introduction

### Applications

---

The 800 Series lantern has the following applications:

- Fixed and floating aids to navigation
- Port, marina and dock lighting
- Offshore platform marking
- Aquaculture
- Tower & crane marking
- Hazard marking and way-finding

### Range

---

The 800 Series Lantern is visible from up to approximately 10 nautical miles (18.5 km) at night depending on the installation location and selected flash setting.

For a detailed understanding of range and intensity capabilities at your installation location, visit our simulation tool at [carmanah.com/selector](http://carmanah.com/selector).

### Common Features and Functionality

---

The 800 Series lantern is a self-contained, high-performance, solar powered light with the following features:

- Easily visible, “tap-to-activate” digital LED display

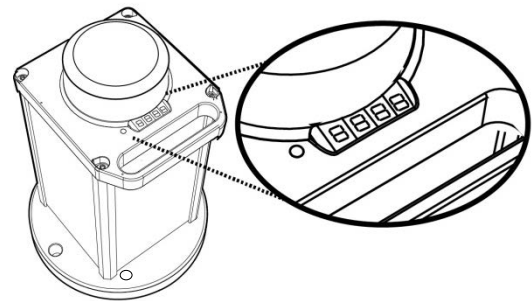

- Latest generation, high-efficiency LEDs and optics
- Simplified installation & setup. No “transitioning” required prior to installation or storage.
- Rugged polycarbonate and aluminum enclosure for maximum durability in a lightweight, economical package
- Calendar function available for automatically de-activating lights during off-season periods
- Optional GPS synchronization for setting any number of lanterns and other Carmanah GPS-equipped lanterns to flash in unison
- Optional secure satellite monitoring and status reporting (M800 lanterns only)

## Parts Description

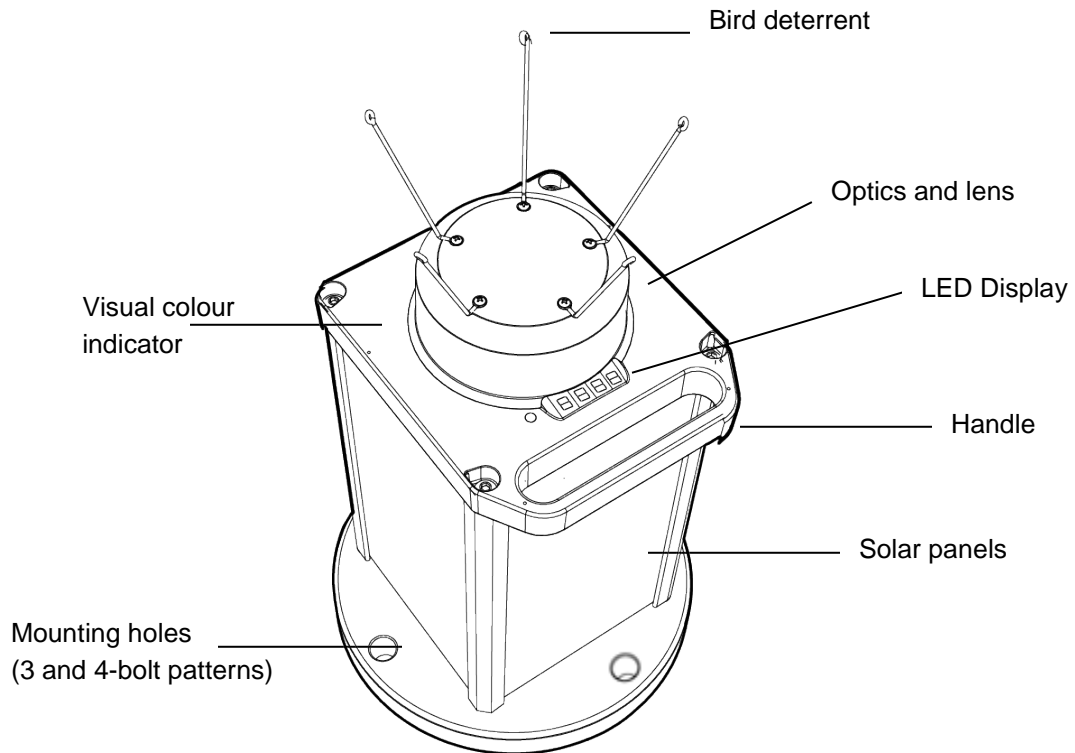

## Programming the Lantern

**NOTE**

Please thoroughly read these instructions before proceeding with the installation.

## Preparing the Lantern for Installation

The 800 Series lantern has been designed with a simplified user experience in mind. Lights are ready for use on shipment and do not have to be “transitioned” from day to night before making changes to settings.

### Pre-Programmed Lanterns

If Carmanah or a Carmanah authorized distributor has programmed the lantern prior to you receiving it, it is ready to install. When the lantern is removed from the box and exposed to light, it will begin normal operation, activating with the next day-to-night transition. Prior to field deployment, **verify that the lantern’s pre-programmed settings match your requirements** using the top-mounted LED display. Refer to the following section on “Viewing Lantern Settings” for details. If you have been supplied with an IR programmer, you may modify lantern settings prior to installation if desired.

### Non-Programmed Lanterns

If you have not requested a pre-programmed lantern, you will need to verify the lantern settings (intensity, flash pattern, calendar function & etc.) and make any required modifications using a Carmanah IR programmer. Refer to the following sections on “Viewing Lantern Settings” and “Using the Infrared (IR) Programmer” for details. If you require a Carmanah IR programmer, please contact Carmanah or your authorized distributor.

## Viewing Lantern Settings

### Quickly Viewing Summary Data

The top-mounted LED Display provides essential summary information about your lantern. To activate the LED Display, tap very quickly three times on the left shoulder or the head of the lantern.

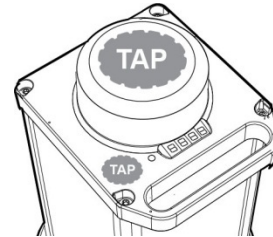

Once activated, the LED Display will show in sequence:

- **Lantern Status**
- **Battery State of Charge & Battery Voltage**
- **Lantern Flash Character**
- **Lantern Effective Intensity**
- **Automatic Light Control (ALC) On/Off**
- **Calendar On/Off**

Refer to the following page for a detailed description of these items.

**NOTE**

Pressing the  button on the IR programmer will also provide quick access to this essential summary information.

### Accessing Complete Data Via the Infrared (IR) Programmer

Use the IR programmer to view complete state and status details, including calendar settings and GPS settings (if applicable). Using the IR programmer, you can also customize flash patterns, adjust calendar settings and more. Refer to the following table for a complete list of visible and programmable lantern settings.

## Summary of Lantern States and Statuses

The following table indicates the data that can be reviewed on the lantern LED Display and, where applicable, customized via the IR programmer.

Display	Description	Values	Programming
StAt	Lantern Mode	On	The lantern is in standard operating mode and will automatically transition between “daytime” (LEDs off) and “evening/night-time” (LEDs on) as ambient light levels change.
		Off	The lantern is in an energy saving mode with the LEDs off. The lantern will reactivate with its last programmed settings only once turned “on” using the IR programmer and exposed to bright light.
		cont	The lantern is in demo mode and will operate continuously until placed in another operating mode. Do not field deploy Lanterns in continuous mode.
		Stor	The lantern is in an energy saving factory storage mode with Infrared functionality temporarily turned off.
bAtt	State of Charge and Battery Voltage	SoC	Displays the current battery state-of-charge as a percent value. A value less than 10 indicates that the lantern LEDs are turned off and Low Voltage Disconnect (LVD) is engaged.
		Volt	Indicates the real-time battery voltage
FLSH	Lantern Flash Character	001-273	Displays the three-digit Flash Character reference number.
			See “Setting the Flash Character” on page 11. Appendix A includes a complete list of available options.

Display	Description	Values		Programming
EInt	Lantern Effective Intensity	1-999 cd	The Effective Intensity of the lantern is displayed in units of candela. This is a measure of the lantern's apparent brightness, and is calculated internally using the Schmidt-Clausen formula. Maximum effective Intensity may be limited by the Flash Character selected. Entering a value that is too high will result in an error message (Err). Always consult the Carmanah lantern simulation tool at <a href="http://carmanah.com/selector">carmanah.com/selector</a> to determine sustainable settings in your installation location.	See "Setting Effective Intensity" on page 12
ALC	Automatic Light Control Settings	on	When ALC mode is set to On, the lantern monitors the battery pack's state-of-charge and reduces the intensity level if the lantern is not receiving sufficient solar energy to maintain the battery pack. ALC is designed to prolong battery life in the event of unusually poor weather over an extended period of time, or excessive bird fouling of the solar panel.	See "Activating/Deactivating Automatic Light Control" on page 13
		oFF		
CAL	Calendar Enable	on	Indicates if the calendar function is on or off.	See "Setting the Calendar Function" on page 13
		oFF		
Con	Calendar ON Date	mon MM day DD	Indicates the date the lantern will enter a dated shutdown period. This field is only visible when the Calendar is enabled.	
CoFF	Calendar OFF Date	mon MM day DD	Indicates the date the lantern will reactivate at the end of a dated shutdown period. This field is only visible when the Calendar is enabled.	
date	Date (displayed on non-GPS-equipped units only)	year YYYY mon MMM day DD	For units <i>without</i> GPS, this indicates the user-programmed date or factory-set UTC. In the event of a battery disconnect, review and, if required, re-program this value. GPS-equipped units operate on Coordinated Universal Time (UTC) and this field is not visible.	See "Editing the Lantern Date and Time (Non-GPS Units Only)" on page 15
time	Time	Hour HH min MM	For units <i>without</i> GPS, this indicates the user-programmed time or factory-set UTC. In the event of a battery disconnect, review and, if required, re-program this value. GPS-equipped units operate UTC and this field is not visible.	See "Editing the Lantern Date and Time (Non-GPS Units Only)" on page 15



Display	Description	Values		Programming
gPS	GPS Status  (For GPS-equipped units only)	Good	GPS Satellite signal found and locked	See “GPS Status (GPS-equipped Lanterns Only)” on page 15
		PAuS	GPS function paused to conserve energy	
		SrcH	Searching for GPS satellite signal	
		nLoC	No lock on GPS satellite signal. Search resumes every 10 minutes.	
SYnC	GPS Synchronization  (For GPS-equipped units only)	on	Indicates if the GPS Synchronization function is on or off.	See “Setting the GPS Synchronization Function (GPS-equipped Lanterns Only)” on page 18
		oFF		
d2n	Day to Night Transition Level (D2N)	025L-400L	Indicates the ambient brightness (in lux) at which the lantern LEDs will turn on in the evening.	See “Setting Day to Night Transition Level” on page 16
n2d	Night to Day Transition Level (N2D)	075L-450L	Indicates the ambient brightness (in lux) at which the lantern LEDs will turn off in the morning.	See Section “Setting Night to Day Transition Level” on page 16
info	Firmware Version	1.x.x.x	Displays the current firmware version. This value may be used by the manufacturer for troubleshooting purposes.	See “Viewing Firmware Version” on page 17
SrcE	Charge Source	Int	The lantern is being charged by the internal solar panels.	See “Charging the Lantern” on page 21
		oPtn	The lantern is being charged by a wall charger or other external source.	
tAP	Tap-to-Activate Enable	on	Turns on or off the “tap-to-activate” functionality of the LED display if desired. Once turned off, an Infrared (IR) programmer is required to view lantern state and status.	See Enable/Disable Tap-to-Activate LED Display Option” on page 17
		oFF		
.	Charging		The lower right decimal point on the LED display will flash regularly to indicate that the lantern is charging.	See “Charging the Lantern” on page 21

## Using the Infrared (IR) Programmer

All functions of the 800 Series lantern are controlled by the IR programmer.

### Important User Notes

**NOTE**

The IR programmer uses one CR2025 battery (shipped with unit). Remove the battery tab from the back of the IR programmer on first use.

**NOTE**

Keep a minimum distance of 6" (15 cm) between the IR programmer and the lantern.

**NOTE**

The Lantern must be in "on" mode to change settings using the IR programmer. If a Lantern is in "off" mode, you may review settings using the  key, but you will not be able to scroll through detailed information or program the lantern.

### The IR programmer includes the following keys:



The **power** key awakens the infrared sensor inside the lantern and allows the unit to accept programming commands.

To conserve power, the 800 Series lantern searches for an Infrared signal on a 0.5 second cycle. You may need to press the power key multiple times to establish a connection. Typically, three steady button presses will be sufficient; however, you may need to make more or fewer connection attempts to coincide with the lantern signal. The lantern LEDs will flash to confirm that a connection has been made. Once a

connection has been made, all IR commands will be received and confirmed with a flash. If no IR signals are received within 60 seconds, the IR receiver will switch back to power saving mode.



The **information** key provides quick access to Lantern Status, Battery State of Charge & Battery Voltage, Lantern Flash Character, Lantern Effective Intensity, Automatic Light Control (ALC) setting, and Calendar On/Off.



Use the **up/down arrow** keys to scroll easily through the LED Display values.



The left/right arrow keys are used to navigate away from a selected menu item, or to move between digits when programming a setting.



Use the **number** keys to directly enter numeric values.



The **(A)** key allows jumps directly to the Flash Character menu to view or edit Flash Character settings.



The **(B)** key jumps directly to the Lantern Effective Intensity menu to view or edit Effective Intensity.



The **set** button unlocks and locks settings. Press this button to change a displayed value (editable settings only) and to lock in an updated value. When a new value is locked, the lantern LEDs and the LED display will flash three times to confirm that the new settings have been registered and are active. If a value is entered that is outside of the lantern's acceptable parameters then "Err" (error) is displayed, the LEDs will flash two times, and the lantern will revert to the previous setting.

## Turning the Lantern On or Off

The 800 Series lantern can be switched into the following two basic operating modes:

- **On:** The lantern is in standard operating mode and will automatically transition between “daytime” (LEDs off) and “evening/night-time” (LEDs on) as ambient light levels change.
- **Off:** The lantern is in an energy saving mode with the LEDs off. The lantern will reactivate with its last programmed settings only once turned “on” using the IR programmer and exposed to bright light.

An additional “Continuous” mode is also available on distributor demo units. Contact [customerservice@carmanah.com](mailto:customerservice@carmanah.com) for the activation code for this mode. To exit continuous mode select On or Off in the Stat menu.

To turn the lantern on or off:

1. If you have not already done so, establish a connection to the lantern.
2. The lantern LEDs will flash to confirm the lantern is ready to receive commands.
3. Press and hold the power button for approximately five seconds until the LED display changes to show “stAt On” or “byE”.

## Setting the Flash Character

A complete list of available Flash Characters is provided in Appendix A.

1. If you have not already done so, establish a connection to the lantern.
2. The lantern LEDs will flash to confirm the lantern is ready to receive commands.
3. Navigate to the FLSH menu or press the **(A)** button to jump directly to this function
4. Unlock the existing setting
5. Use the number keys to direct enter the desired Flash Character (see Appendix A).
6. Lock the new setting
7. The lantern LEDs will flash to confirm that the new setting has been locked.

The 800 Series has intelligent settings to prevent the lantern from operating with certain Flash Character and Effective Intensity combinations. Effective Intensity may be automatically lowered when you change Flash Characters. ALWAYS review Effective Intensity after changing Flash Characters.



Review the online simulator at [carmanah.com/selector](http://carmanah.com/selector) to find Flash Character and Effective Intensity combinations that are sustainable in your installation location.















## Setting Effective Intensity

The Effective Intensity of the lantern is a measure of its apparent brightness in candela. It takes into account the reduction from peak intensity caused by the Schmidt Clausen factor.

### Setting an Intensity to Comply with Obstruction Lighting Standards









Users of the OL800 Series Obstruction Lights may wish to program the light to meet a specific Obstruction specification.

-  If you have not already done so, establish a connection to the lantern.
-  The lantern LEDs will flash to confirm the lantern is ready to receive commands.

Specification	Enter Key Sequence
FAA L-810 (AC 150/5345-43, EB67)	 6-3-3 
ICAO Type A (Annex 14, Vol. 1, 5 <sup>th</sup> Ed./2009)	 6-1-3 
ICAO Type A (Annex 14, Vol. 1, 6 <sup>th</sup> Ed./2013)	 6-2-3 
ICAO Type B (Annex 14, Vol. 1, 5 <sup>th</sup> Ed./2009)	 6-4-1 
ICAO Type B (Annex 14, Vol. 1, 6 <sup>th</sup> Ed./2013)	 6-7-2 
CASA 10 cd (Part 133, Vol. 2)*	 6-1-3 
Transport Canada CD-810 (Std. 621)	 6-6-6 

\* Code 613 satisfies the requirements of both CASA 10cd and ICAO Type A (Annex 14, Vol. 1, 5<sup>th</sup> Ed./2009).

### For all other applications:

-  1. If you have not already done so, establish a connection to the lantern.
-  2. The lantern LEDs will flash to confirm the lantern is ready to receive commands.
-    
or  3. Navigate to the Elnt menu or press the **(B)** button to jump directly to this function
-  4. Unlock the existing setting
-  5. Use the number keys to direct enter the desired Effective Intensity.
-  6. Lock the new setting
-  7. The lantern LEDs will flash to confirm that the new setting has been locked.

#### NOTE







The 800 Series has intelligent settings to prevent the lantern from running with certain Flash Character and Effective Intensity combinations. You may receive an error (Err) message if you are attempting to enter a value that is not compatible with your programmed Flash Character. Choose a lower value or modify your Flash Character to resolve this issue.

#### NOTE

To protect battery life, always consult the online simulator at [carmanah.com/selector](http://carmanah.com/selector) to find the maximum sustainable intensity for your installation location.





## Activating/De-activating Automatic Light Control (ALC)

When ALC mode is set to “on”, the lantern monitors the battery pack’s state of health and reduces the intensity level if there is insufficient solar energy to maintain the battery pack.

1.  If you have not already done so, establish a connection to the lantern.
2.  The lantern LEDs will flash to confirm the lantern is ready to receive commands.
3.  Navigate to the ALC menu
4.  Unlock the existing setting
5.  Toggle between “on” and “off”
6.  Lock the new setting
7.  The lantern LEDs will flash to confirm that the new setting has been locked.

**NOTE**

To quickly change ALC settings, you may direct enter one of the following quick access codes:

-  **8-0-1**  (to activate)
-  **8-0-0**  (to deactivate)

When ALC intervenes, the LEDs brightness is reduced. Set the ALC to off if your application demands that the lantern meets specific intensity requirements at all times.









## Setting the Calendar Function

The Calendar Function allows you to specify a dated shutdown if desired.

**NOTE**

GPS-enabled lanterns will be synched to Coordinated Universal Time (UTC). For units without GPS, check the LED Display for the current date and time and, if required, update the date setting prior to programming the calendar function.









### To toggle the Calendar setting on or off:

4.  If you have not already done so, establish a connection to the lantern.
5.  The lantern LEDs will flash to confirm the lantern is ready to receive commands.
6.  Navigate to the CAL menu.
7.  Unlock the existing setting
8.  Toggle between “on” and “off”
9.  Lock the new setting
10.  The lantern LEDs will flash to confirm that the new setting has been locked.

### To set the date that the lantern will enter dated shutdown:









Confirm that the Calendar is turned “on”.

1.  Navigate to the Con menu

- 
-  2. Scroll to the Month value (ΠΠon)
  -  3. Unlock the existing setting
  -  4. Use the number keys to enter the month when dated shutdown will begin.
  -  5. Lock the new setting
  -  6. Scroll to the day value (dAY)
  -  7. Use the number keys to enter the specific day of the month when dated shutdown will begin.
  -  8. Lock the new setting
  -  9. The lantern LEDs will flash to confirm that the new setting has been locked.

### To set the date the lantern will reactivate:

Confirm that the Calendar is turned “on”.

-  1. Navigate to the CoFF menu
-  2. Scroll to the Month value (ΠΠon)
-  3. Unlock the existing setting
-  4. Use the number keys to enter the month when dated shutdown will end.
-  5. Lock the new setting
-  6. Scroll to the day value (dAY)
-  7. Use the number keys to enter the specific day of the month when dated shutdown will end.
-  8. Lock the new setting
-  9. The lantern LEDs will flash to confirm your change.









## Editing the Lantern Date and Time (Non-GPS Units Only)

Lantern Date and Time are used for data logging and for controlling the calendar function. The 800 Series lantern (without GPS) has an internal clock which it uses for logging activity. The lantern will be factory programmed in Coordinated Universal Time (UTC). You may re-program the lantern to local date and time if desired. In the event that the lantern battery pack is disconnected, verify the date settings and reset if required.

**NOTE**

GPS-equipped units will be synchronized to Coordinated Universal Time (UTC). The date/time settings on GPS-equipped units cannot be modified.

### To edit the lantern date:

1.  If you have not already done so, establish a connection to the lantern.
2.  The lantern LEDs will flash to confirm the lantern is ready to receive commands.
3.  Navigate to the date menu
4.  Scroll to the Month value (ΠΠον)
5.  Unlock the existing setting
6.  Use the number keys to enter the current month.
7.  Lock the new setting
8.  Scroll to the Day value (dAY)
9.  Use the number keys to enter the current day.



10. Lock the new setting



The lantern LEDs will flash to confirm that the new setting has been locked.

### To edit the lantern time:



1. If you have not already done so, establish a connection to the lantern.



2. The lantern LEDs will flash to confirm the lantern is ready to receive commands.



3. Navigate to the Time menu



4. Scroll to the hour value (HH)



5. Unlock the existing setting



6. Use the number keys to enter the current hour (24-hour clock).



7. Lock the new setting



8. Scroll to the minute value (MM)



9. Use the number keys to enter the current minute



10. Lock the new setting



11. The lantern LEDs will flash to confirm that the new setting has been locked.









## Setting Day-to-Night Transition Level

The Day to Night Transition level (D2N) is the ambient brightness (in lux), at which the lantern's LEDs will turn on in the evening. A higher value for the D2N Transition level causes the LEDs to turn on earlier; a lower value causes it to turn on later.

**NOTE**

Remember that the earlier the lantern turns on, the more battery power it consumes. Therefore, higher D2N Transition Level settings lower the Effective Intensity Limit and Projected Autonomy slightly.

To set the D2N Transition Level (between 025 and 400L):

1.  If you have not already done so, establish a connection to the lantern.
2.  The lantern LEDs will flash to confirm the lantern is ready to receive commands.
3.  Navigate to the D2N menu
4.  Unlock the existing setting
5.  Use the number keys to enter a value in lux. Once programmed, the lantern LEDs will turn on when ambient brightness decreases to this lux value.
6.  Lock the new setting
7.  The lantern LEDs will flash to confirm that the new setting has been locked.







## Setting Night-to-Day Transition Level

As the sun rises, the ambient light level goes up. The night to day level (N2D) is the ambient light level (in lux) at which the lantern's LEDs turns off in the morning. A lower N2D turns the LEDs off earlier in the day.

**NOTE**

The later the lantern turns off, the more battery power it consumes. Therefore, higher N2D Transition Level settings lower the Effective Intensity Limit and Projected Autonomy slightly.

To set the N2D Transition Level (between 075 and 450L):

1.  If you have not already done so, establish a connection to the lantern.
2.  The lantern LEDs will flash to confirm the lantern is ready to receive commands.
3.  Navigate to the N2D menu
4.  Unlock the existing setting
5.  Use the number keys to enter a value in lux. Once programmed, the lantern LEDs will turn off when ambient brightness increases to this lux value.
6.  Lock the new setting
7.  The lantern LEDs will flash to confirm that the new setting has been locked.

**NOTE**

The N2D Transition Level must be at least 50L greater than the D2N Transition Level. The D2N level will be automatically adjusted if required.









## Enable/Disable Tap-to-Activate LED Display Option

---

With Tap-to-Activate enabled, a quick triple tap on the left shoulder or head of the lantern will activate the LED Display to list the lantern's status, battery state of charge & voltage, Flash Character, Effective Intensity, ALC On/Off, and Calendar On/Off. In some locations where the lantern may be subject to extreme movement or jostling, this function may be disabled to minimize power consumption from unintentional activation of the LED Display.



To toggle this setting:

-  1. If you have not already done so, establish a connection to the lantern.
-  2. The lantern LEDs will flash to confirm the lantern is ready to receive commands.
-  3. Navigate to the tAP menu.
-  4. Unlock the existing setting
-  5. Toggle between "on" and "off"
-  6. Lock the new setting
-  7. The lantern LEDs will flash to confirm that the new setting has been locked.

## Viewing Firmware Version

---

To determine your firmware version:

-  1. If you have not already done so, establish a connection to the lantern.
-  2. The lantern LEDs will flash to confirm the lantern is ready to receive commands.
-  3. Navigate to the info menu. The 4-digit firmware version will scroll in from the right.







## Setting the GPS Synchronization Function (GPS-equipped Lanterns Only)

To activate the GPS synchronization functionality of the 800 Series lantern SYnC must be set to “on”. Once activated, GPS-equipped lanterns automatically synchronize with GPS-equipped lanterns set to the same flash character; however, it can take several minutes for lanterns to synchronize. The synchronization period is dependent on the number of satellites overhead and any obstructions from buildings or mountainous terrain.

**NOTE**

GPS-equipped lanterns will be synched to Coordinated Universal Time (UTC). The date/time settings on GPS-equipped units cannot be modified.

### To toggle GPS Synchronization on or off:



1.  If you have not already done so, establish a connection to the lantern.
2.  The lantern LEDs will flash to confirm the lantern is ready to receive commands.
3.  Navigate to the SYnC menu.
4.  Unlock the existing setting
5.  Toggle between “on” and “off”
6.  Lock the new setting
7.  The lantern LEDs will flash to confirm that the new setting has been locked.

## GPS Status (GPS-equipped Lanterns Only)

GPS-equipped lanterns have the following four additional status flags:

- ◆ **Good:** GPS Satellite signal found and locked
- ◆ **PAuS:** GPS function has been paused to conserve energy. This will occur when GPS function is not in use; for example, when the **lantern is in “stead-on” mode (flash code 001)**, or when the lantern is in dated shutdown.
- ◆ **SrcH:** The GPS unit is searching for a satellite signal
- ◆ **nLoC:** The unit was unable to find and lock a GPS satellite signal. Search will resume every 10 minutes at night and every 45 minutes during the day until a signal is found.

To determine GPS state:

1.  If you have not already done so, establish a connection to the lantern.
2.  The lantern LEDs will flash to confirm the lantern is ready to receive commands.
3.  Navigate to the gPS menu. The GPS state will scroll in from the right.

## Installing a Lantern

### Choosing a Suitable Location

Adequate sunlight and suitable ambient temperature are the two most important factors to consider when choosing a location for Carmanah solar lanterns.

#### Adequate Sunlight

The 800 Series lantern is powered by solar energy stored inside the rechargeable batteries of the lantern; therefore, to operate each night it requires an adequate amount of sunlight to recharge its batteries. The following factors should be considered when installing the lantern:

- ◆ the amount of sunlight available in the region
- ◆ an unobstructed view of the sun (the lantern should not be shaded)
- ◆ seasonal changes in sun angle

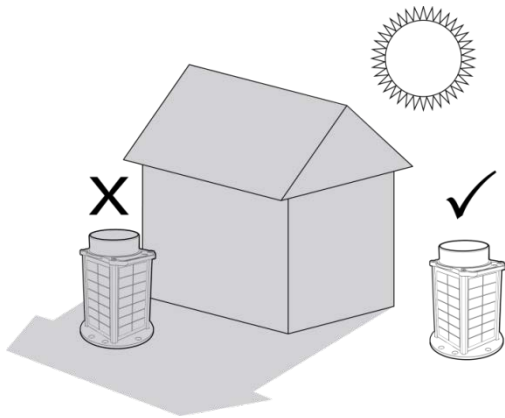

#### Ambient Temperature

The temperature range of the lantern location must be between  $-22$  to  $122$  °F ( $-30$  to  $50$  °C).

## Securing the Lantern

**NOTE**

Physically modifying the 800 Series lantern will void the warranty. This includes drilling additional holes in the base or re-drilling the existing mounting holes to a larger diameter.

The lantern base plate has six mounting holes intended for three or four-point mounting patterns. The use of security fasteners is recommended to prevent theft. Use 18-8 stainless steel hex head fasteners with  $\frac{1}{2}$  -13 UNC thread. Tighten the fasteners to 40 to 44 lbf·ft (4.5 to 5.0 N·m).

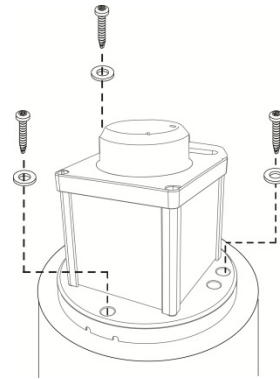

**Option A**

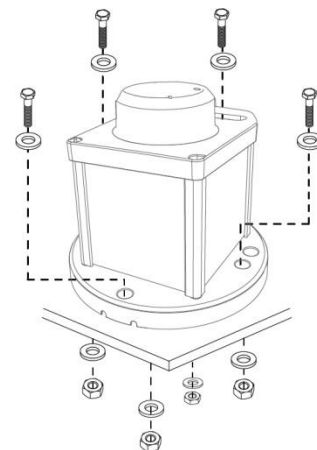

**Option B**

## Installing the Bird Deterrent

The 800 Series lantern is shipped with a bird deterrent in the form of five stainless steel deterrents that screw directly into the lantern head. Stainless steel screws are included in the product package.



To prevent damage to the lantern head, use only the supplied bird deterrent and screw set.

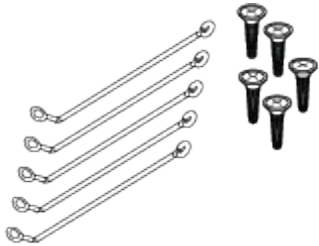

***Bird Deterrent & Screw Set Supplied***

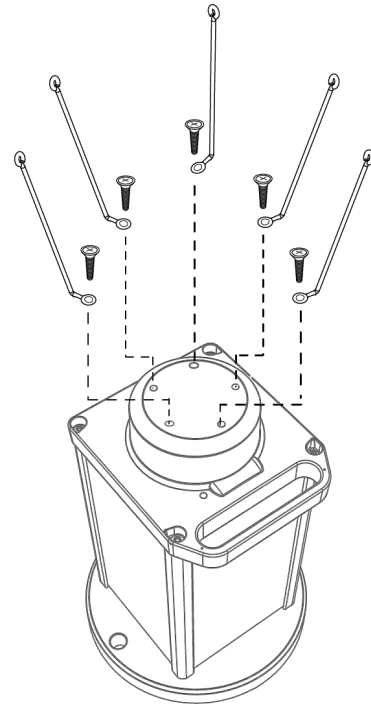

***Attaching the Bird Deterrent***

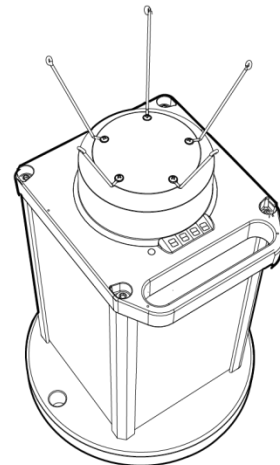

***Bird Deterrent Installed***

## Charging the Lantern

If the lantern batteries have a charge of less than 80%, they require charging.

It is recommended that you place the 800 Series lantern in Off mode for charging. When it is in Off mode, the lantern can continue to charge using light on the solar panels, but does not turn on in darkness.

To place the lantern into Off mode, follow the command sequence described on page 11, “Turning the Lantern On or Off”.

### Sunlight

If available, sunlight is the easiest way to charge multiple lanterns. The 800 Series lantern will typically require five to 10 days to fully charge from sunlight. Additional charging time may be required in extremely low light conditions.

### External Power Source

The 800 Series lantern may also be equipped with a quick-access external charge port located in the base of the lantern. Alternately, the lantern housing may be removed to access an internal port. Using either of these options, the light may achieve a full state-of-charge overnight by connecting the charge port to an external power source. The wall charger is intended for indoor use only. Carmanah will supply a wall charger with adapter on request.

### Charge Indicator

When the battery is charging either from sunlight or from the external charger, a single point on the lower right of the lantern’s LED display will flash.

**NOTE**

If the lantern has been stored improperly, the batteries may be sulphated and will not accept a charge. A new battery may be required.

## Charging via an External Power Source (Quick Access Charge Port)

Step 1: Tilt the lantern and open the water-tight charge-port cap.



Step 2: Connect the Carmanah-supplied charger accessory to the charge port.



Step 3: Align the charger cord with the cord channel at the base of the lantern.

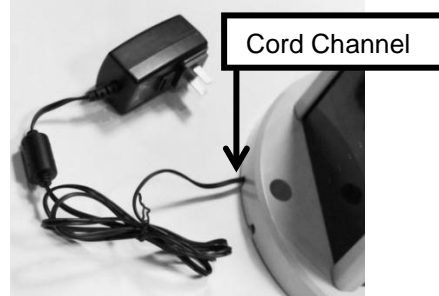

Step 4: Plug in the charger and let charge overnight. Wait a minimum of one hour and verify battery state-of-charge. The most accurate Battery Pack status reading is obtained when the lantern has been in a dark location and in “off” mode for at least 24 hours.

## Determining Battery State of Charge

It is important to check battery charge levels before storing a lantern and prior to deployment to ensure it will be fully operational in the field.

The most accurate Battery Pack status reading is obtained when the lantern has been in a dark location and in Off mode for at least 24 hours.

Battery status (bAtt) is displayed as a menu item on the lantern LED display and includes the following two data points:

- SoC: This value indicates the percent state-of-charge of the battery in real-time. We recommend that battery state-of-charge is above 90% prior to deployment.
- volt: This value indicates the real-time voltage of the lantern. Note that the lantern may ship with one of three battery packs (60X, 96E or 200BC). Lantern voltages varies depending on the battery pack supplied.

Battery Pack	Nominal Voltage
60X	6.3V
96E	6.3V
200BC	8.4V

### Quick View: Tap-To-Activate

Quickly tap the left shoulder or head of the lantern to activate the LED display. The LED Display will rotate through essential summary information. Battery settings (bAtt), state-of-charge (SoC) and real-time voltage (volt) will scroll in from the right.

### Quick View: IR programmer



1. If you have not already done so, establish a connection to the lantern.



2. The lantern LEDs will flash to confirm the lantern is ready to receive commands.



3. Press the information key. Battery settings (bAtt), state-of-charge (SoC) and real-time voltage (volt) will scroll in from the right.

## Changing the Battery

Battery replacement kits can be ordered directly from Carmanah or from your authorized distributor. Multiple battery sizes are available. Consult the table below to match you 800 Series lantern with an appropriate battery pack.

Pack Type	Part No.	Suitable for:
60X	69954	M850 OL800 Compact
96E	69955	M850/M860, OL800 Standard
200BC	69956	M860 OL800 Large

Required tools:

- Replacement Carmanah battery pack and parts bag
- ¼" hex driver handle (required)
- Ratchet with driver adapter (required)
- ½" socket (required)



Remove all jewelry including rings and bracelets. Bridging battery terminals with any metal could cause high electrical currents and severe burns.

1. Turn the light off (refer to page 11 of this manual for details).
2. Turn the lantern on its side. Use the ratchet and driver to remove the four base plate screws.

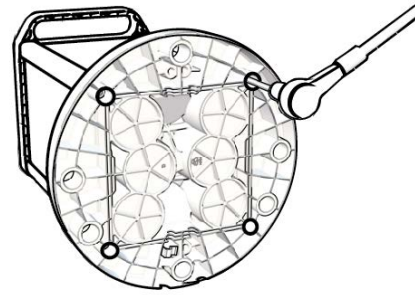

3. Hold the lantern by the base and head and carefully return it to an upright position.
4. With the lantern in an upright position, slowly lift the housing away from the base plate.

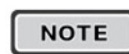

The base plate and housing alignment.

5. Disconnect the battery harness and place the housing to one side.

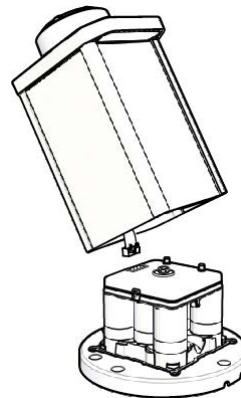

6. Using the ½" socket, remove the center bolt and washer.

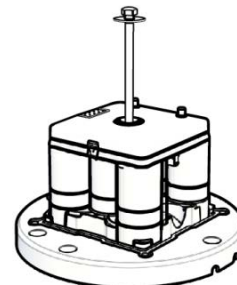



7. Lift out the battery pack. Remove the old black rubber gasket in the lantern base and replace it with the new one supplied.

**NOTE** Carefully check the gasket to ensure it is seated in the base plate.

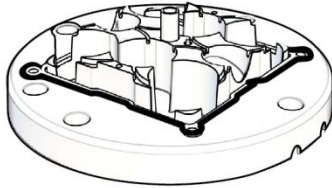

8. Position the replacement pack in the lantern base. Attach the new pack to the base using the centre bolt and washer. Torque centre bolt to 40 inch lbs.

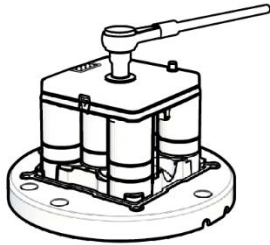

9. Place the lantern housing back over the battery pack and re-connect the battery harness.
10. Carefully turn the lantern on its side. Inspect the lantern to ensure that no wires or gaskets are pinched.
11. Re-connect all four (4) base plate screws. Tighten each screw down to 50 inch lbs using a calibrated torque wrench.

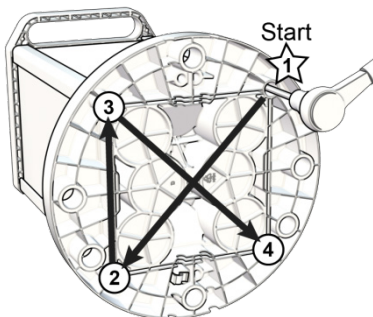



## Preparing the Lantern for Storage

**NOTE**

It is important to have a full battery charge when placing the lantern into storage. A fully charged battery ensures maximum shelf life and minimizes the possibility of battery damage due to low-charge states. Even in Storage Mode, the lantern will continue to consume a small amount of power.

To ensure optimal product life complete the following steps prior to storing the lantern.

- Check the current battery status of the lantern. If the battery is not fully charged, follow the charging instructions in this guide.
- Place the lantern in “off” mode using the IR programmer. Follow the instructions in this guide on page 11, “Turning the Lantern On or Off”.

## Storage Maintenance/Duration

---

Elevated storage temperatures increase the rate of battery self-discharge. The optimum storage temperature for the 800 Series lantern is 68°F (20°C) or cooler.

Ensure that you have fully charged your 800 Series lantern and placed it in “off” mode before placing it in storage.

## Warranty and Customer Service

### Warranty

---

This product is covered by the Carmanah warranty. Visit [www.carmanah.com/content/products/warranty/](http://www.carmanah.com/content/products/warranty/) for additional information.

### Additional Products

---

Carmanah offers a variety of solar-powered and energy-efficient LED lighting products and accessories. For more information visit [carmanah.com](http://carmanah.com).

---

## Customer Service

---

Before contacting Carmanah's customer service department, please have the serial number of the lantern available, a brief description of the problem, as well as all details of installation and recharging efforts.

To contact Carmanah's Customer Service Department:

**Mail:**

Carmanah Technologies Corporation  
250 Bay Street  
Victoria, BC Canada V9A 3K5

**Phone:**

1.250.380.0052  
877.722.8877 (Toll Free in U.S. and Canada)

**Fax:** 1.250.380.0062

**Email:** [customerservice@carmanah.com](mailto:customerservice@carmanah.com)

**Website:** [carmanah.com](http://carmanah.com)

**Appendix A: Flash Characters**

Flash Code	Flash Character	FL1	EC1	FL2	EC2	FL3	EC3	FL4	EC4	FL5	EC5	FL6	EC6	FL7	EC7	FL8	EC8	FL9	EC9
000	System Off Mode	0	0																
001	F	60	0																
002	FI(2) 10s	0.5	1	0.5	8														
003	FI(2) 10s	0.5	1.5	0.5	7.5														
004	FI(2) 10s	0.8	1.2	0.8	7.2														
005	FI(2) 10s	1	1	1	7														
006	FI(2) 10s	1	1.5	1	6.5														
007	FI(2) 12s	0.5	1	0.5	10														
008	FI(2) 12s	1.5	2	1.5	7														
009	FI(2) 15s	1	2	1	11														
010	FI(2) 5s	0.5	1	0.5	3														
011	FI(2) 5s	1	1	1	2														
012	FI(2) 6s	0.5	1	0.5	4														
013	FI(2) 6s	0.8	1.2	0.8	3.2														
014	FI(2) 6s	1	1	1	3														
015	FI(2) 7s	1	1	1	4														
016	FI(2) 8s	0.5	1	0.5	6														
017	FI(2) 8s	1	1	1	5														
018	FI(2+1) 10s	0.5	0.7	0.5	2.1	0.5	5.7												
019	FI(2+1) 12s	0.8	1.2	0.8	2.4	0.8	6												
020	FI(2+1) 12s	1	1	1	4	1	4												
021	FI(2+1) 15s	1	2	1	5	1	5												
022	FI(2+1) 6s	0.3	0.4	0.3	1.2	0.3	3.5												
023	FI(3) 12S	0.5	2	0.5	2	0.5	6.5												
024	FI(3) 10s	0.5	1.5	0.5	1.5	0.5	5.5												
025	FI(3) 10s	1	1	1	1	1	5												
026	FI(3) 12s	0.8	1.2	0.8	1.2	0.8	7.2												
027	FI(3) 15s	0.3	1.7	0.3	1.7	0.3	10.7												
028	FI(3) 15s	0.5	1.5	0.5	1.5	0.5	10.5												

Flash Code	Flash Character	FL1	EC1	FL2	EC2	FL3	EC3	FL4	EC4	FL5	EC5	FL6	EC6	FL7	EC7	FL8	EC8	FL9	EC9
029	FI(3) 20s	0.5	3	0.5	3	0.5	12.5												
030	FI(3) 9s	0.8	1.2	0.8	1.2	0.8	4.2												
031	FI(4) 10s	0.5	1	0.5	1	0.5	1	0.5	5										
032	FI(4) 10s	0.8	1.2	0.8	1.2	0.8	1.2	0.8	3.2										
033	FI(4) 12s	0.8	1.2	0.8	1.2	0.8	1.2	0.8	5.2										
034	FI(4) 15s	0.5	1.5	0.5	1.5	0.5	1.5	0.5	8.5										
035	FI(4) 15s	1	1	1	1	1	1	1	8										
036	FI(4) 20s	0.5	1.5	0.5	1.5	0.5	1.5	0.5	13.5										
037	FI(5) 20s	0.8	1.2	0.8	1.2	0.8	1.2	0.8	1.2	0.8	11.2								
038	FI(5) 20s	1	1	1	1	1	1	1	1	1	11								
039	FI(6) 15s	0.5	1	0.5	1	0.5	1	0.5	1	0.5	1	0.5	7						
040	FL-*	5	1	1	1														
041	FL-**	5	1	1	1	1	1												
042	FI 1.5s	0.3	1.2																
043	FI 1.5s	0.5	1																
044	FI 10s	0.5	9.5																
045	FI 10s	1	9																
046	FI 10s	1.5	8.5																
047	FI 12s	1.2	10.8																
048	FI 15s	1	14																
049	FI 2.5s	0.3	2.2																
050	FI 2.5s	0.5	2																
051	FI 2.8s	0.3	2.5																
052	FI 2s	0.2	1.8																
053	FI 2s	0.3	1.7																
054	FI 2s	0.4	1.6																
055	FI 2s	0.5	1.5																
056	FI 2s	0.7	1.3																
057	FI 2s	0.8	1.2																
058	FI 3s	0.3	2.7																
059	FI 3s	0.5	2.5																
060	FI 3s	0.7	2.3																

Flash Code	Flash Character	FL1	EC1	FL2	EC2	FL3	EC3	FL4	EC4	FL5	EC5	FL6	EC6	FL7	EC7	FL8	EC8	FL9	EC9
061	FI 3s	1	2																
062	FI 4.3s	1.3	3																
063	FI 4.4s	0.4	4																
064	FI 4s	0.5	3.5																
065	FI 4s	0.8	3.2																
066	FI 4s	1	3																
067	FI 4s	1.5	2.5																
068	FI 5s	0.3	4.7																
069	FI 5s	0.5	4.5																
070	FI 5s	1	4																
071	FI 5s	1.5	4.5																
072	FI 6s	0.5	5.5																
073	FI 6s	0.6	5.4																
074	FI 6s	1	5																
075	FI 6s	1.5	3.5																
076	FI 7.5s	0.8	6.7																
077	ISO 10S	5	5																
078	ISO 2S	1	1																
079	ISO 4S	2	2																
080	ISO 5S	2.5	2.5																
081	ISO 6S	3	3																
082	ISO 8S	4	4																
083	ISO 3S	1.5	1.5																
084	LFL 10S	2	8																
085	LFL 10S	3	7																
086	LFL 10S	4	6																
087	LFL 12S	2	10																
088	LFL 15S	4	11																
089	LFL 5S	2	3																
090	LFL 6S	2	4																
091	LFL 8S	2	6																
092	LFL 8S	3	5																

Flash Code	Flash Character	FL1	EC1	FL2	EC2	FL3	EC3	FL4	EC4	FL5	EC5	FL6	EC6	FL7	EC7	FL8	EC8	FL9	EC9
093	MO(A) 10S	0.5	0.5	1.5	7.5														
094	MO(A) 15s	0.5	1.5	2	11														
095	MO(A) 6s	0.3	0.6	1	4.1														
096	MO(A) 8s	0.8	1.2	2.4	3.6														
097	MO(B) 15S	1.5	0.5	0.5	0.5	0.5	0.5	0.5	10.5										
098	MO(U) 10S	0.3	0.7	0.3	0.7	0.9	7.1												
099	MO(U) 10S	0.4	0.6	0.4	0.6	1.2	6.8												
100	MO(U) 10S	0.5	0.5	0.5	0.5	1.5	6.5												
101	MO(U) 15S	0.5	0.5	0.5	0.5	1.5	11.5												
102	MO(U) 15S	0.6	0.3	0.6	0.3	1.4	11.8												
103	MO(U) 15S	0.7	0.5	0.7	0.5	1.9	10.7												
104	MO(U) 15S	0.7	0.7	0.7	0.7	2.1	10.1												
105	MO(U) 15S	0.75	0.45	0.75	0.45	2	10.6												
106	MO(U) 15S	1.15	0.73	1.15	0.73	3.03	8.21												
107	MO(U) 15S	1.3	0.7	1.3	0.7	3.3	7.7												
108	MO(U) 15S****	0.75	0.15	0.75	0.15	1.65	11.55												
109	MO(U) 15S*	0.45	0.45	0.45	0.45	1.35	11.85												
110	MO(U) 15S**	0.55	0.35	0.55	0.35	1.45	11.75												
111	MO(U) 15S***	0.6	0.3	0.6	0.3	1.5	11.7												
112	MO(U) 10S	0.2	0.8	0.2	0.8	0.6	7.4												
113	OC 10S	7	3																
114	OC 10S	7.5	2.5																
115	OC 15S	10	5																
116	OC 3S	2	1																
117	OC 3S	2.5	0.5																
118	OC 4S	3	1																
119	OC 5S	3	2																
120	OC 5S	4	1																
121	OC 5S	4.5	0.5																
122	OC 6S	4	2																
123	OC 6S	4.5	1.5																
124	OC 6S	5	1																

Flash Code	Flash Character	FL1	EC1	FL2	EC2	FL3	EC3	FL4	EC4	FL5	EC5	FL6	EC6	FL7	EC7	FL8	EC8	FL9	EC9
125	Q 1.2S	0.3	0.9																
126	Q 1.2S	0.5	0.7																
127	Q 1.2S	0.6	0.6																
128	Q 1S	0.2	0.8																
129	Q 1S	0.3	0.7																
130	Q 1S	0.4	0.6																
131	Q 1S	0.5	0.5																
132	Q 1S	0.8	0.2																
133	Q(2) 10S	0.5	1.5	0.5	7.5														
134	Q(2) 10S	0.6	0.4	0.6	8.4														
135	Q(2) 5S	0.3	0.7	0.3	3.7														
136	Q(2) 6S	0.3	0.7	0.3	4.7														
137	Q(2) 6S	0.35	0.7	0.35	4.6														
138	Q(3) 10S	0.3	0.7	0.3	0.7	0.3	7.7												
139	Q(3) 10S	0.35	0.65	0.35	0.65	0.35	7.65												
140	Q(3) 10S	0.6	0.6	0.6	0.6	0.6	7												
141	Q(4) 10S	0.3	0.7	0.3	0.7	0.3	0.7	0.3	6.7										
142	Q(4) 12S	0.3	0.7	0.3	0.7	0.3	0.7	0.3	8.7										
143	Q(4) 15S	0.35	0.7	0.35	0.7	0.35	0.7	0.35	11.5										
144	Q(4) 20S	0.5	0.5	0.5	0.5	0.5	0.5	0.5	16.5										
145	Q(4) 6S	0.4	0.6	0.4	0.6	0.4	0.6	0.4	2.6										
146	Q(5) 10S	0.3	0.7	0.3	0.7	0.3	0.7	0.3	0.7	0.3	5.7								
147	Q(5) 20S	0.3	0.7	0.3	0.7	0.3	0.7	0.3	0.7	0.3	15.7								
148	Q(5) 20S	0.5	0.5	0.5	0.5	0.5	0.5	0.5	0.5	0.5	15.5								
149	Q(5) 7S	0.3	0.7	0.3	0.7	0.3	0.7	0.3	0.7	0.3	2.7								
150	Q(6) 10S	0.3	0.7	0.3	0.7	0.3	0.7	0.3	0.7	0.3	0.7	0.3	4.7						
151	Q(6)+LFL 15S	0.3	0.7	0.3	0.7	0.3	0.7	0.3	0.7	0.3	0.7	0.3	0.7	2	7				
152	Q(6)+LFL 15S	0.35	0.65	0.35	0.65	0.35	0.65	0.35	0.65	0.35	0.65	0.35	0.65	1.05	7.95				
153	Q(6)+LFL 15S	0.6	0.6	0.6	0.6	0.6	0.6	0.6	0.6	0.6	0.6	0.6	0.6	2	5.8				
154	Q(9) 15S	0.3	0.7	0.3	0.7	0.3	0.7	0.3	0.7	0.3	0.7	0.3	0.7	0.3	0.7	0.3	0.7	0.3	6.7
155	Q(9) 15S	0.35	0.65	0.35	0.65	0.35	0.65	0.35	0.65	0.35	0.65	0.35	0.65	0.35	0.65	0.35	0.65	0.35	6.65
156	Q(9) 15S	0.6	0.6	0.6	0.6	0.6	0.6	0.6	0.6	0.6	0.6	0.6	0.6	0.6	0.6	0.6	0.6	0.6	4.8

Flash Code	Flash Character	FL1	EC1	FL2	EC2	FL3	EC3	FL4	EC4	FL5	EC5	FL6	EC6	FL7	EC7	FL8	EC8	FL9	EC9
157	VQ 0.5S	0.15	0.35																
158	VQ 0.5S	0.2	0.3																
159	VQ 0.6S	0.2	0.4																
160	VQ 0.6S	0.3	0.3																
161	VQ(3) 5S	0.15	0.35	0.15	0.35	0.15	3.85												
162	VQ(3) 5S	0.2	0.3	0.2	0.3	0.2	3.8												
163	VQ(3) 5S	0.3	0.3	0.3	0.3	0.3	3.5												
164	VQ(6)+LFL 10S	0.2	0.3	0.2	0.3	0.2	0.3	0.2	0.3	0.2	0.3	0.2	0.3	2	5				
165	VQ(6)+LFL 10S	0.3	0.3	0.3	0.3	0.3	0.3	0.3	0.3	0.3	0.3	0.3	0.3	2	4.4				
166	VQ(9) 10S	0.15	0.35	0.15	0.35	0.15	0.35	0.15	0.35	0.15	0.35	0.15	0.35	0.15	0.35	0.15	0.35	0.15	5.85
167	VQ(9) 10S	0.2	0.3	0.2	0.3	0.2	0.3	0.2	0.3	0.2	0.3	0.2	0.3	0.2	0.3	0.2	0.3	0.2	5.8
168	VQ(9) 10S	0.3	0.3	0.3	0.3	0.3	0.3	0.3	0.3	0.3	0.3	0.3	0.3	0.3	0.3	0.3	0.3	0.3	4.9
169	Q(2) 7S	0.5	1	0.5	5														
170	FI(2) 5s	0.3	0.4	0.3	4														
171	FI(2) 10s	0.5	0.7	0.5	8.3														
172	FI(5) 20s	0.5	1	0.5	1	0.5	1	0.5	1	0.5	13.5								
173	FI(2) 10s	1	2	1	6														
174	FI 4s	0.4	3.6																
175	FI(2) 5s	0.4	0.6	0.4	3.6														
176	Mo(A) 8s	0.4	0.6	2	5														
177	FI 2.5s	1	1.5																
178	FI(3+1) 20 s	0.5	1.5	0.5	1.5	0.5	4.5	0.5	10.5										
179	FI(3+1) 20 s	0.6	1.4	0.6	1.4	0.6	4.4	0.6	10.4										
180	FI(3+1) 20 s	0.65	1.35	0.65	1.35	0.65	4.35	0.65	10.35										
181	FI(3+1) 20 s	0.7	1.3	0.7	1.3	0.7	4.3	0.7	10.3										
182	FI(3+1) 20 s	0.8	1.2	0.8	1.2	0.8	4.2	0.8	10.2										
183	FI(2) 7s	0.5	1.5	0.5	4.5														
184	FI(3) 9s	0.5	1.5	0.5	1.5	0.5	4.5												
185	LFL 11s	2	9																
186	FI(6+1) 15s	0.5	0.5	0.5	0.5	0.5	0.5	0.5	0.5	0.5	0.5	0.5	0.5	2	7				
187	Mo (0) 12s	1.5	0.5	1.5	0.5	1.5	6.5												
188	Mo (0) 15s	1.5	0.5	1.5	0.5	1.5	9.5												



Flash Code	Flash Character	FL1	EC1	FL2	EC2	FL3	EC3	FL4	EC4	FL5	EC5	FL6	EC6	FL7	EC7	FL8	EC8	FL9	EC9
189	Q 1S	0.25	0.75																
190	Q (3) 4.6s	0.3	0.7	0.3	2	0.3	1												
191	FI 7.5s	0.5	7																
192	FI (4) 11s	0.5	1.5	0.5	1.5	0.5	1.5	0.5	4.5										
193	FL (3) 21s	0.5	1.5	0.5	4.5	0.5	13.5												
194	FL (3) 6s	0.5	0.5	0.5	0.5	0.5	3.5												
195	FL(3)10s	0.5	0.5	0.5	0.5	0.5	7.5												
196	FL(9)15s	0.5	0.5	0.5	0.5	0.5	0.5	0.5	0.5	0.5	0.5	0.5	0.5	0.5	0.5	0.5	0.5	0.5	6.5
197	OC(2)6s	3	1	1	1														
198	OC(3)8s	3	1	1	1	1	1												
199	OC(4)10s	3	1	1	1	1	1	1	1										
200	FL(2)6s	0.5	1.5	0.5	3.5														
201	FL(1)8s	0.5	7.5																
202	FL(3)15s	0.3	1.7	0.3	1.7	0.3	10.7												
203	FL(2)5s	0.2	0.8	0.2	3.8														
204	FL(2)4s	0.5	1	0.5	2														
205	FL(2)4.5s	0.3	1	0.3	2.9														
206	FL(3)10s	0.5	1.5	0.5	1.5	0.5	5.5												
207	FL(3)15s	0.5	1.5	0.5	1.5	0.5	10.5												
208	Mo(B)16s	1.5	0.5	0.5	0.5	1.5	0.5	0.5	10.5										
209	Q 1s	0.15	0.85																
210	FI(2+1) 10s	0.6	0.6	0.6	1.8	0.6	5.8												
211	MO(U) 15S	0.4	0.5	0.4	0.5	1.2	12												
212	Q 1.2S	0.2	1																
213	Q(3) 10S	0.2	1	0.2	1	0.2	7.4												
214	Q(6)+LFL 15S	0.6	0.6	0.6	0.6	0.6	0.6	0.6	0.6	0.6	0.6	0.6	0.6	3	4.8				
215	VQ(3) 5S	0.2	0.4	0.2	0.4	0.2	3.6												
216	VQ(6)+LFL 10S	0.3	0.3	0.3	0.3	0.3	0.3	0.3	0.3	0.3	0.3	0.3	0.3	3	3.4				
217	VQ(9) 10S	0.2	0.4	0.2	0.4	0.2	0.4	0.2	0.4	0.2	0.4	0.2	0.4	0.2	0.4	0.2	0.4	0.2	5
218	OC (3) 12S	4.5	1.5	1.5	1.5	1.5	1.5												
219	OC(4) 12S	5	1	1	1	1	1	1	1										
220	FL(3) 12S	1	1.5	1	1.5	1	6												

Flash Code	Flash Character	FL1	EC1	FL2	EC2	FL3	EC3	FL4	EC4	FL5	EC5	FL6	EC6	FL7	EC7	FL8	EC8	FL9	EC9
221	FL(4) 15S	1	1.5	1	1.5	1	1.5	1	6.5										
222	FL(5) 20S	1	1.5	1	1.5	1	1.5	1	1.5	1	9								
223	MO(A)	1	1	3	7														
224	FL(5) 20S SADO	0.5	1.5	0.5	1.5	0.5	1.5	0.5	1.5	0.5	11.5								
225	FL(4) 15S	0.5	2	0.5	2	0.5	2	0.5	7										
226	FL(5) 20S	0.5	2	0.5	2	0.5	2	0.5	2	0.5	9.5								
227	Q(6)+LFL 15S	0.2	1	0.2	1	0.2	1	0.2	1	0.2	1	0.2	1	3	4.8				
228	Q(9) 15S	0.2	1	0.2	1	0.2	1	0.2	1	0.2	1	0.2	1	0.2	1	0.2	1	0.2	5.2
229	VQ(6)+LFL 10S	0.2	0.4	0.2	0.4	0.2	0.4	0.2	0.4	0.2	0.4	0.2	0.4	3	3.4				
230	CST1	3.273	1.091	1.091	1.091	3.273	1.091	1.091	30										
231	CST2	6	15																
232	LFL 24s	9	15																
233	CST4	3	10																
234	CST5	0.5	1	0.5	1	0.5	4.5												
235	CST6	0.4	0.7	0.4	0.7	0.4	0.7	0.4	0.7	0.4	20.2								
236	CST7	1.5	0.5																
237	CST8	0.5	2.5	0.5	2.5	0.5	2.5	0.5	10.5										
238	CST9	0.6	0.3	0.6	0.3	1.5	56.7												
239	CST10	0.5	1.5	0.5	2.5														
240	CST11	0.3	0.7	0.3	2.7														
241	CST12	6	6																
242	CST13	2	1	5	1														
243	CST14	0.4	0.6	0.4	0.6	0.4	2.6												
244	CST15	0.8	1	0.8	1	0.8	1	0.8	1	0.8	2								
245	CST16	0.8	1	0.8	1	0.8	1	0.8	3.8										
246	CST17	0.5	0.5	0.5	0.5	0.5	5.5												
247	CST18	0.5	2.5	0.5	2.5	0.5	2.5	0.5	10.5										
248	CST19	0.8	5.2																
249	CST20	0.8	6.2																
250	CST21	0.5	2	0.5	2	0.5	2	0.5	8										
251	FI 3.5s	0.7	2.8																
252	FI 3.6s	0.7	2.9																

Flash Code	Flash Character	FL1	EC1	FL2	EC2	FL3	EC3	FL4	EC4	FL5	EC5	FL6	EC6	FL7	EC7	FL8	EC8	FL9	EC9	
253	FI 5.5s	0.7	4.8																	
254	FI(3) 15s	0.5	1.5	0.5	3	0.5	9													
255	GpD(5) 14s	0.5	1.5	0.5	1.5	0.5	1.5	0.5	1.5	0.5	5.5									
256	GpD(5) 15s	0.5	1.5	0.5	1.5	0.5	1.5	0.5	1.5	0.5	6.5									
257	ISO 2.5S	1.25	1.25																	
258	FI(3) 10s	0.5	1.5	0.5	0.5	1.5	5.5													
259	CST22	1	2	1	2	1	2	1	2	1	7									
260	CST23	0.25	2.25																	
261	CST24	0.5	0.7	0.5	3.3															
262	CST25	0.5	1	0.5	3	0.5	9													
263	CST26	1.5	0.5	1.5	0.5	1.5	0.5	4.5	0.5											
264	CST27	0.5	1.5	0.5	1.5	0.5	4.5	0.5	13.5											
265	CST28	1.5	0.5	0.5	0.5	0.5	4.5													
266	CST29	0.5	0.5	1.5	4.5															
267	CST30	0.25	0.25																	
268	CST31	0.25	0.25	0.25	0.25	0.25	3.75													
269	CST32	0.25	0.25	0.25	0.25	0.25	0.25	0.25	0.25	0.25	0.25	0.25	0.25	0.25	0.25	0.25	0.25	0.25	0.25	5.75
270	CST33	0.25	0.25	0.25	0.25	0.25	0.25	0.25	0.25	0.25	0.25	0.25	0.25	2	5					
271	CST34	0.5	0.7	0.5	2.1	0.5	9.7													
272	CST35	0.5	0.7	0.5	2.1	0.5	7.7													
273	CST36	0.5	1.5	0.5	1.5	0.5	1.5	0.5	5.5											

## Appendix B: Troubleshooting

Failure	Possible Cause	Recommendation
The IR programmer will not connect to the lantern	IR programmer battery	On a new IR programmer, confirm that the protective battery tab on the bottom back of the IR programmer has been removed and that the battery is charged. For an older IR programmer confirm that the batteries are charged.
	The lantern searches for an IR signal on a 0.5 second cycle. The lantern's search signal may not coincide with the push of the power button, or there may be local interference.	Place the programmer close (no more than 6" or 15 cm) to the top clear lens. Press the power button on the IR programmer quickly and repeatedly over a period of two seconds. The lantern LEDs should flash when a connection has been established.
	A new lantern may have been shipped in factory mode and been received within two hours.	Tap quickly three times on the lantern head or left shoulder to activate the LED display. If the "stat" menu item shows a status of "stor", leave the lantern for two hours (from the time the display was activated). After a two hour period, the lantern will automatically switch from "stor" to "on".
The tap-to-activate function does not turn on the LED display	Tap-to-activate has been turned off	You will need an IR programmer to reactivate this function following the instructions on page 17 of this manual.
The IR programmer will not edit the lantern's settings – or all menu items are not appearing on the display.	The lantern may be in "off" mode.	Tap quickly three times on the lantern head or left shoulder to activate the LED display or press  several times on the IR programmer. Verify if the lantern status (stat) is "off. Follow the instructions "Turning the Lantern On or Off" as described on page 11 Turning the Lantern On or Off of this manual.
An Error (Err) message appears when programming a lantern	The value entered is invalid	An Error (Err) message appears when attempting to enter a value that exceeds the lantern's acceptable parameters. For dates and times: Verify that the value entered is a valid calendar date. For Flash Character or Effective Intensity: Review the online simulator tool at <a href="http://carmanah.com/selector">carmanah.com/selector</a> and confirm sustainable settings for your installation location.
Lantern beam/LEDs do not turn on	The environment is too bright to activate the lantern	The lantern automatically turns on in the dark – test it in a dark environment. Check the day-to-night transition level following the instructions on page 16 of this manual.
	The lantern is in low voltage disconnect state	Charge the battery. If the charging indicator LED is not flashing, follow the charging instruction on page 21 of this manual.

Failure	Possible Cause	Recommendation
The lantern beam/LEDs do not turn off	The lantern is in a continuous demonstration mode (intended for distributor and factory use only) or the lantern is being used indoors under florescent lights.	Change the lantern state to “on” or “off” following the instructions on page 11 of this manual.
Lantern is dim	Effective intensity setting is lower than desired.	Verify the lantern’s Effective Intensity settings following the detailed instructions on page 12 of this manual. Consult the Carmanah online simulator at <a href="http://carmanah.com/selector">carmanah.com/selector</a> to find a sustainable intensity for your installation location.
	The ALC function has activated	Tap quickly three times on the lantern head or left shoulder to activate the LED display. Review the data on the LED display to verify if ALC is “on” and if the lantern’s battery state-of-charge (bAtt SoC) is low. Follow the charging instruction on page 21 of this manual.
GPS equipped lanterns will not synchronize.	GPS sync not enabled	Change the “SyNC: setting to “on” following the instructions on page 18 of this manual.
	The lantern flash codes are not the same.	Verify that all GPS equipped lanterns are set to the same flash code.



© 2014 Carmanah Technologies Corporation  
carmanah.com

**Technical support:** [customerservice@carmanah.com](mailto:customerservice@carmanah.com)  
Toll Free in Canada and the U.S.: 1.877.722.8877  
International: 1.250.380.0052 | Fax: 1.250.380.0062

Number: 69928\_8xx\_UserManual\_RevB

---

we put solar to work®

---

© 2014, Carmanah Technologies Corporation. Revised July 2014. 69928\_8xx\_UserManual\_RevB