

## IMPORTANT NOTICE

All rights to this manual are owned solely by SATEL OY (referred to in this user guide as SATEL). All rights reserved. The copying of this manual (without the written permission from the owner) by printing, copying, recording or by any other means, or the full or partial translation of the manual to any other language, including all programming languages, using any electrical, mechanical, magnetic, optical, manual or other methods or devices is forbidden.

SATEL reserves the right to change the technical specifications or functions of its products, or to discontinue the manufacture of any of its products or to discontinue the support of any of its products, without any written announcement and urges its customers to ensure, that the information at their disposal is valid.

SATEL software and programs are delivered "as is". The manufacturer does not grant any kind of warranty including guarantees on suitability and applicability to a certain application. Under no circumstances is the manufacturer or the developer of a program responsible for any possible damages caused by the use of a program. The names of the programs as well as all copyrights relating to the programs are the sole property of SATEL. Any transfer, licensing to a third party, leasing, renting, transportation, copying, editing, translating, modifying into another programming language or reverse engineering for any intent is forbidden without the written consent of SATEL.

**SATEL PRODUCTS HAVE NOT BEEN DESIGNED, INTENDED NOR INSPECTED TO BE USED IN ANY LIFE SUPPORT RELATED DEVICE OR SYSTEM RELATED FUNCTION NOR AS A PART OF ANY OTHER CRITICAL SYSTEM AND ARE GRANTED NO FUNCTIONAL WARRANTY IF THEY ARE USED IN ANY OF THE APPLICATIONS MENTIONED.**

Salo, FINLAND 2008

## RESTRICTIONS ON USE

The models SATELLINE-1870 and 1870E (referred to in this user guide as SATELLINE-1870) are designed to operate in the countries listed below on the licence free frequency band of 868.000 – 870.000 MHz (not incorporating the band 869.2-869.25MHz) according to the recommendation CEPT/ERC/REC 70-03. This recommendation has been drawn up by the European Radio communications Committee (ERC) under CEPT. In this recommendation there has been defined limits for the use of transmit/receive duty cycle and radiated output power.

In addition, please pay attention to the possible local restrictions stated by the national radio authorities.

SATELLINE-1870 is allowed to be use in the CEPT countries according to the following list:

- AT, BE, BG, DE, DK, EE, FI, FR, GR, HR, IS, IE, IT, NL, NO, PL, PT, SK, ES, SE, CH, UK and ZA.

SATELLINE-1870E is allowed to be use in the CEPT countries according to the following list:

- AT, BE, DK, FI, FR, DE, GR, IS, IT, NL, NO, PL, PT, SK, ES, SE, CH and UK.

## PRODUCT CONFORMITY

Hereby, SATEL Oy, declares that SATELLINE-1870 radio modem is in compliance with the essential requirements and other relevant provisions of Directive 1999/5/EC. Therefore the equipment is labelled with the following CE –marking.

**CE 0523**

### DECLARATION of CONFORMITY

In Accordance with  
**1999/5/EC Directive**

of the European Parliament and of the Council of 9 March 1999 on radio equipment and telecommunications terminal equipment and the mutual recognition of their conformity

Doc No: SATEL-DC-RTTE-067

**Manufacturer:** SATEL Oy  
**Address:** P.O.Box 142, ( Meriniitynkatu 17 )  
24101 Salo  
Finland

Products :	Type	Model	
	<b>SATEL_TA1</b>	<b>SATELLINE-1870E</b>	Radio Modem
	<b>SATELLINE-1870</b>	<b>SATELLINE-1870</b>	Radio Modem

**Notified Body Opinion:** according to: Annex IV of R&TTE Directive  
Document Nr: FI08700004  
Issued by: Finnish Communications Regulatory Authority  
Dated On: 7<sup>th</sup> of March, 2008  
Notified Body Nr. 0523

We, the manufacturer of the above mentioned products, hereby declare that these products conform to the essential requirements of the European Union directive 1999/5/EC. This Declaration of Conformity is based on the following documents:

Doc. No	Type of Product	Test Specification	Date of Issue	TEST LABORATORY
80599	SATEL_TA1	EN 300 220-3 and EN 300 220-2	14.03.2007	NEMKO, Espoo, Finland
80601A	SATEL_TA1	EN 301 489-1 and EN 301 489-3	27.03.2007	NEMKO, Espoo, Finland
80601B	SATEL_TA1	2004/104/EC	27.03.2007	NEMKO, Espoo, Finland
80601S1	SATEL_TA1	Attestation Satel	08.05.2007	NEMKO, Espoo, Finland
80602	SATEL_TA1	EN 60950-1	30.05.2007	NEMKO, Espoo, Finland

Salo on the 12<sup>th</sup> of March, 2008.

SATEL Oy

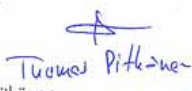
  
Tuomas Pitkänen  
Managing Director

SATEL Oy  
P.O.Box 142, FI-24101 SALO, FINLAND  
Street: Meriniitynkatu 17, FI-24100 SALO, FINLAND  
Tel: +358 2 777 7800, Fax: +358 2 777 7810  
E-mail: info@satel.com, www.satel.com

 **SATEL**<sup>®</sup>  
WIRELESS WORLD – LOCAL SOLUTION



## WARRANTY AND SAFETY INSTRUCTIONS

Read these safety instructions carefully before using the product:

- Warranty will be void, if the product is used in any way, which is in contradiction with the instructions given in this manual, or if the housing of the radio modem has been opened or tampered with.
- The radio modem is to be used only on frequencies allocated by local authorities and without exceeding the given maximum allowed output power ratings. SATEL is not responsible, if any products manufactured by it are used in unlawful ways.
- The devices mentioned in this manual are to be used only according to the instructions described in this manual. Faultless and safe operation of the devices can be guaranteed only if the transport, storage, operation and handling of the devices is appropriate. This also applies to the maintenance of the products.
- To prevent damage to both the radio modem and any terminal devices must always be switched OFF before connecting or disconnecting the serial connection cable. It should be ascertained that different devices used have the same ground potential. Before connecting any power cables the output voltage of the power supply should be checked.
- It is possible to connect the device to an outdoor antenna or a cable distribution system. In these cases, in order to conduct the possible over voltages due to lightings to earth, the equipment should be connected to protective earth by using the mounting screws of the device.
- This is a requirement in order to be in compliance with the electrical safety regulations (EN 60950-1).

## TABLE OF CONTENTS

IMPORTANT NOTICE.....	1
RESTRICTIONS ON USE .....	2
PRODUCT CONFORMITY .....	3
WARRANTY AND SAFETY INSTRUCTIONS.....	4
TABLE OF CONTENTS .....	5
INTRODUCTION .....	8
<b>1 SATELLINE-1870 RADIO DATA MODEM .....</b>	<b>9</b>
1.1 SATELLINE-1870 Technical specifications .....	9
1.2 General information on the 868-870 MHz SRD band .....	10
1.2.1 Usage .....	10
1.2.2 Sub-bands .....	10
1.2.3 Duty cycle .....	10
1.2.4 Power level .....	10
1.2.5 Channel assignment .....	12
1.3 Basic configuration and installation .....	13
1.3.1 Mounting in vehicular environment .....	14
<b>2 CONNECTIONS .....</b>	<b>15</b>
2.1 DIN41651-16pin connector functions .....	15
2.1.1 Pin configuration .....	15
2.1.2 RS-232 interface .....	17
<b>3 RF INTERFACE .....</b>	<b>18</b>
3.1 Transmitter.....	18
3.2 Receiver.....	19
3.3 TX Priority ON/OFF .....	20
3.4 Error checking .....	20
3.5 Limit radio frame length.....	22

<b>4</b>	<b>USER INTERFACE</b>	<b>23</b>
4.1	LED-indicators	23
4.2	Self diagnostics	23
4.3	Programming Mode	24
4.3.1	Changing the settings	24
4.3.2	Restoring factory settings	25
<b>5</b>	<b>TRANSPARENT DATA TRANSMISSION</b>	<b>26</b>
5.1	Serial interface, data format	26
5.2	Handshake lines	27
5.2.1	CTS-line	27
5.2.2	RTS-line	29
5.3	Timing and delays during data transmission	29
5.3.1	Data buffering in the radio data modem	29
5.3.2	Pause length	30
5.3.3	TX-delay	36
5.4	Tests	40
5.4.1	Short block test	41
5.4.2	Long block test	41
5.4.3	Carrier test	41
5.4.4	SATELLINE-1870 test string	41
5.4.5	Monitoring the test transmission using the receiver	41
<b>6</b>	<b>REPEATER MODE AND ADDRESSING</b>	<b>42</b>
6.1	Repeater	42
6.1.1	Connecting a repeater to a local DTE	43
6.2	Addressing	43
6.2.1	Primary and secondary transmit and receive addresses	43
6.2.2	Reading the address from the user protocol	46
6.2.3	Hop Count (Time to Live=TTL)	49
6.2.4	Connection between two points	50
6.3	Using repeaters and addresses in the same system	50
6.3.1	Repeater chain using dual addressing	50
6.3.2	Parallel repeater chains using dual addressing	51
<b>7</b>	<b>SETTINGS</b>	<b>53</b>
7.1	Changing parameters using a terminal device	53
7.1.1	Changing frequency (active radio channel frequency)	54

7.1.2	Changing radio settings (power and sensitivity).....	55
7.1.3	Changing addressing.....	57
7.1.4	Changing serial port settings .....	58
7.1.5	Modification of handshaking functions .....	61
7.1.6	Special functions .....	61
7.1.7	Activating tests.....	62
7.1.8	Restoring factory settings .....	62
7.1.10	Saving modified settings into the permanent memory.....	63
<b>7.2</b>	<b>Changing parameters using the SL-COMMANDS .....</b>	<b>63</b>
7.2.1	Frequency.....	64
7.2.2	Extended SL commands.....	64
7.2.3	Addressing.....	64
7.2.4	Radio parameters .....	65
7.2.5	Other functions .....	66
<b>8</b>	<b>POWER SUPPLY.....</b>	<b>67</b>
<b>9</b>	<b>ACCESSORIES AND ADDITIONAL EQUIPMENTS .....</b>	<b>68</b>
9.1	RS Cables .....	68
9.2	RF Cables .....	68
9.3	Antenna.....	68
9.4	Additional equipments .....	68
<b>APPENDIX A</b> .....		<b>69</b>

## INTRODUCTION

SATEL Oy is a Finnish electronics and telecommunications company specialised in the design and manufacturing of wireless data communication products. SATEL designs, manufactures and sells radio modems intended for use in applications ranging from data transfer to alarm relaying systems. End users of SATEL products include industrial companies, public organisations and private persons.

SATEL is the leading European manufacturer of radio modems. SATEL radio modems have been certified in most European countries and also in many non-European countries.

Primary characteristics of SATELLINE – 1870 are listed below:

- o SATELLINE-1870 radio has a raw data rate of 9.6 kbps using 25 kHz channel spacing.
- o SATELLINE-1870 radio modems DTE-interface is electrically compatible with the RS-232 serial interface. RD, TD, RTS, CTS, DTR, DSR lines are implemented.
- o SATELLINE-1870 radio modem software can be updated through the service connector using a PC and a special programming device.

### **User guide version information**

User Guide version 4 is applicable for SATELLINE-1870 having the software version 2.0 or later OR hardware version UCTC8L or later.



# 1 SATELLINE-1870 RADIO DATA MODEM

## 1.1 SATELLINE-1870 Technical specifications

SATELLINE-1870 complies with the following international standards: ETS 300 220-1 (radio requirements), EN 301 489-1 (EMC-requirements) and EN 60950-1 (electrical safety). All parameters are given for room temperature (°25C) if not mentioned otherwise.

### RADIO TRANSCEIVER

Frequency Range	868 .... 870 MHz (programmable)
Channel Spacing	25 kHz
Frequency Stability	<±2.5 kHz (-25 °C ... +55 °C, aging not included)
Type of Emission	F1D
Communication Mode	Half-Duplex

### RADIO TRANSMITTER

Carrier Power	
- 1870	5, 10, 25, 50, 100 mW / 50 ohm (programmable)
- 1870E	5, 10, 25, 50, 100, 250, 500 mW / 50 ohm (programmable)
Carrier Power Stability	Conditions for power stability: -25 ... 55°C +0 ... - 1 dB @ 100 ... 500 mW / +0 ... -3 dB @ 5 ... 50 mW
Adjacent Channel Power	< -37 dBm

### RADIO RECEIVER

Sensitivity	< -108 dBm (BER 10E-3)
Adjacent Channel Selectivity	> 45 dB (typical)
Blocking (typical)	> 75 dB @±1MHz, > 85 dB @±10MHz

### MODEM

Interface	RS-232
Interface Connector	DIN41650-16 pin (male)
Date Speed of DTE Interface	300 – 19200 bps
Data Speed of Radio Interface	9600 bps

### GENERAL

Temperature Ranges	
- Operating	-25 °C ... +55 °C (tests acc. to ETSI standards) -40 °C ... +75 °C (absolute minimum/maximum)
- Storage	-40 °C ... +85 °C
Antenna Connector	SMA, 50 ohm, female
Housing / Size H x W x D	Aluminium enclosure / 57 x 125 x 16 mm
Weight	125 g
Operating Voltage	+ 8 ... + 30 VDC

### POWER CONSUMPTION

Input voltage [V]	Operation mode (typical values)					
	Receive [mA]	Transmit on different power levels [mA]			Power save [mA]	Standby [uA]
		500mW	100mW	5mW		
8	136	444	244	168	25	55
12	89	296	166	105	19	62
30	40	128	76	47	13	1717

**NOTE ! Values are subject to change without notice.**

## **1.2 General information on the 868-870 MHz SRD band**

According to the recommendation CEPT/ERC/REC 70-03 new common spectrum allocations for Alarms and Short Range Devices (SRD) have been taken into use in countries, which are a member of CEPT (The European Conference of Postal and Telecommunications Administrations). The 868 ... 870 MHz band is divided into sub-bands according to the transmit power and transmitter duty cycle used.

### **1.2.1 Usage**

Most sub-bands are assigned for SRD applications such as:

- Telemetry, Telecommand and Telecontrol
- Alarms

Some sub-bands are reserved solely for alarm systems. The intended usage (SRD / Alarms) for each sub-band is indicated in the table below.

### **1.2.2 Sub-bands**

Each sub-band is defined by a start and stop frequency. Furthermore the maximum allowed power level and maximum duty cycle is defined separately for each sub-band.

### **1.2.3 Duty cycle**

The purpose of the duty cycle limit is to ensure that no single application can occupy this license-free band for more than a certain percentage of time. The term duty cycle defines the percentage of a 1-hour period a single modem is allowed to transmit. The duty cycle limitation is to be controlled by the terminal equipment connected to the modem. The modem does not limit the duty cycle.

### **1.2.4 Power level**

The power level limit is defined separately for each sub-band. The maximum power limit for each sub-band is pre-programmed into the SATELLINE-1870. The user can choose from 5, 10, 25, 50, 100 and 500 mW ERP\* output power. No matter what power level the user has chosen the maximum allowed power level of the chosen sub-band cannot be exceeded.

\*ERP = The effective radiated power from the antenna relative to a half-wave dipole in a certain direction.

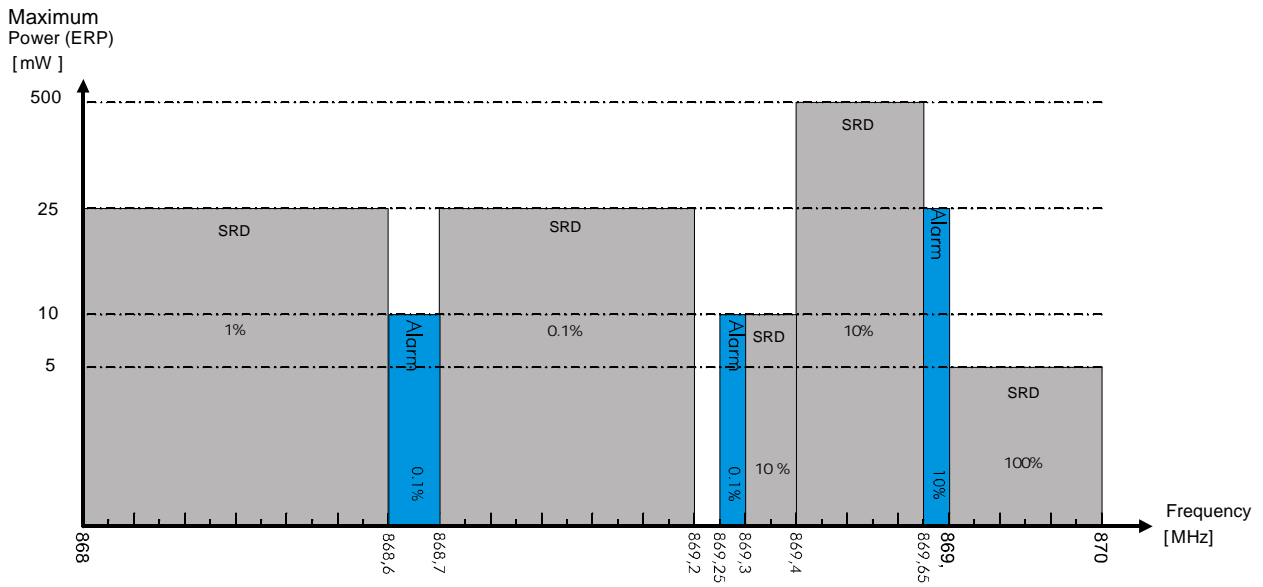

The values for the sub-bands in the previous table are provided here for reference only and the user is encouraged to check the latest national and European regulations concerning the frequency band used before the use of this modem.

### 1.2.5 Channel assignment

Each sub-band is divided into 25 kHz channels according to a channel assignment scheme defined by the recommendation CEPT/ERC/REC 70-03. The channel assignment table below is calculated as follows.

Centre frequency of the lowest channel within a sub-band: sub-band lower limit + 12.5 kHz.

Centre frequency of the highest channel within a sub-band: sub-band upper limit – 12.5 kHz.

The table below lists the centre frequencies for each channel on each sub-band. Furthermore the corresponding channel numbers are shown. Channel numbers are mainly used when changing channels with SL commands.

CHANNELS AND SUBBANDS PRE-PROGRAMMED IN SATELLINE –1870(E) FOR THE 868-870 MHz BAND								
Subband no.	1	2	3	4	5	6	7	8
Subband freq. [MHz]	868.00-868.60	868.6-868.7	868.7-869.2	869.25-869.3	869.3-869.4	869.4-869.65	869.65-869.7	869.7-870
Ch no.	Centre freq [MHz]							
1	868.0125	868.6125	868.7125	869.2625	Not available	869.4125	869.6625	869.7125
2	868.0375	868.6375	868.7375	869.2875		869.4375	869.6875	869.7375
3	868.0625	868.6625	868.7625			869.4625		869.7625
4	868.0875	868.6875	868.7875			869.4875		869.7875
5	868.1125		868.8125			869.5125		869.8125
6	868.1375		868.8375			869.5375		869.8375
7	868.1625		868.8625			869.5625		869.8625
8	868.1875		868.8875			869.5875		869.8875
9	868.2125		868.9125			869.6125		869.9125
10	868.2375		868.9375			869.6375		869.9375
11	868.2625		868.9625					869.9625
12	868.2875		868.9875					869.9875
13	868.3125		869.0125					
14	868.3375		869.0375					
15	868.3625		869.0625					
16	868.3875		869.0875					
17	868.4125		869.1125					
18	868.4375		869.1375					
19	868.4625		869.1625					
20	868.4875		869.1875					
21	868.5125							
22	868.5375							
23	868.5625							
24	868.5875							

### 1.3 Basic configuration and installation

The radio modem is shipped with the following default settings (unless specifically ordered with settings other than those listed below):

Radio Frequency Range	868 ... 870 MHz
Channel Spacing	25 kHz
Serial Interface Type	RS-232

ADJUSTABLE SETTINGS	
Radio Settings	Output power = 100 mW @ 1870 / 500 mW @ 1870E, RSSI threshold -113 dBm
Addressing	All addressing modes are set to OFF
Serial Port 1	9600 / 8 bit data / None / 1 stop bit
Handshaking	CTS Clear to send / RTS Ignored
Additional settings	Error check OFF / Repeater OFF / SL-Commands OFF / Radio TX priority ON, Limit radio frame length OFF
Tests	OFF

Connect the power cables (+Vb and GND) to a power supply with an output voltage of 8 – 30 Vdc and with a minimum output current large enough to provide power for the chosen output power and voltage.

When creating a test connection, you can use the *SaTerm 4* terminal program, available for free from authorised SATEL dealers or directly from SATEL Customer Support. You can also use the HyperTerminal-program, which is included in most Windows™ based operating system packages, or almost any other terminal program. Basic settings for the serial port of the host computer when using a terminal program to communicate with SATEL radio modems are as follows: "COM1, 9600 bps, 8-bit data, none parity, 1 stop bit". If the serial port designated as COM1 in the host computer is reserved, any other free serial port in the host computer can be used (with the settings listed).

#### **NOTE!**

Please note that the *Programming mode* of the radio modem always uses the following communication parameters: "9600 bps, no parity, 1 stop bit".

The basic connection between a radio modem and the serial port COM1 (RS-232) of a PC is described in the schematic below.

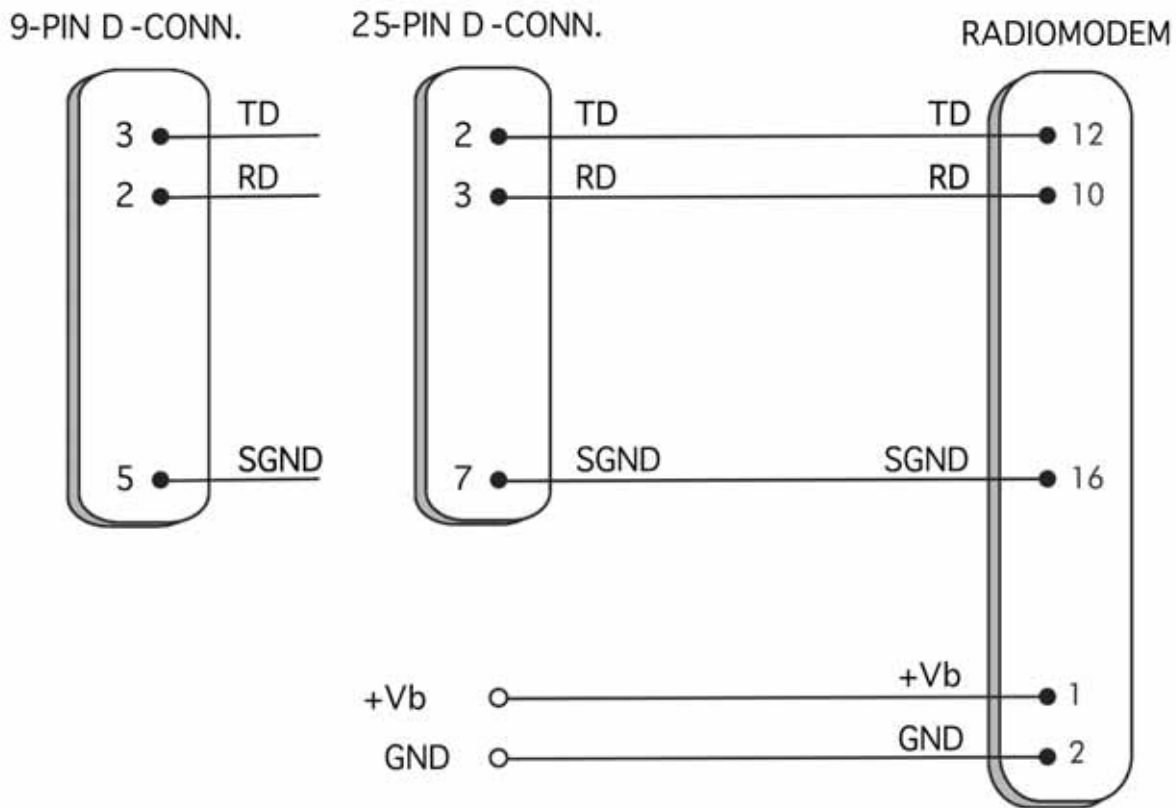

NOTE ! The modem has an internal fuse; no external fuse is required (except in vehicular use, see section 1.3.1).

### 1.3.1 Mounting in vehicular environment

When installing the modem in a vehicle, with the battery "-" in the chassis of the vehicle, it is recommended to use a fuse (approx 1...2A) in the ground wires to the modem (GNS and SGND). In vehicular use the modem chassis is often connected to the vehicle chassis, either deliberately or thru the antenna ground. If this is the case, and the modem ground wire is connected to the "-" pole of the vehicle battery, and the battery "-" pole has a bad connection to the vehicle chassis (due to corrosion etc.), excessive currents can flow thru the modem, as it serves as the return path for the currents drawn from the vehicle battery. These excessive currents will in the worst case destroy the modem.

## 2 CONNECTIONS

### 2.1 DIN41651-16pin connector functions

The radio modem is referred to as DCE (Data Communication Equipment) whereas the PC is referred to as DTE (Data Terminal Equipment). SATELLINE-1870 radio modem includes a 16-pin DIN41651-type male connector, which contains all the connections required to establish communication between the radio modem, acting as the DCE, and the PC, acting as the DTE.

All EMC-requirements set forth by authorities have been taken into account in the design of the radio modem. The user of the radio modem is thereby not required to take any special actions regarding EMC-shielding of the radio modem.

#### **NOTE!**

When the PROG-pin (pin 7 of the DIN41651-16pin -connector) is connected to ground, the radio modem is in the *Programming Mode*.

#### 2.1.1 Pin configuration

The pin configuration of the SATELLINE – 1870 is defined in the following table.  
The picture below indicates the order of the pins.

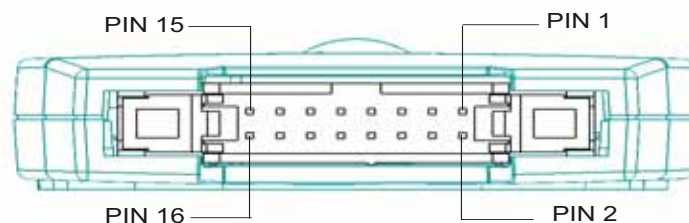

DIN41651-16 pin male connector of the radio modem  
(the modem DTE-connector facing the viewer).

Direction **IN** is data from DTE (Data Terminal Equipment) to the radio modem.  
Direction **OUT** is data from the radio modem to the DTE.

PIN	DIR.	NAME	EXPLANATION
<b>RS-232 PINS</b>			
9	OUT	DSR	<b>Data set ready</b> Instruction: Indicates that the radio modem is switched ON (internally connected to the DTR pin). Connecting a load to DSR without connecting a driving source to DTR cause the modem to enter the STBY mode.
10	OUT	RD	<b>Receive Data</b> , Output of the data received over radio. Data from the radio modem to the DTE.
11	IN	RTS	<b>Request to send</b> , Handshake signal.
12	IN	TD	<b>Transmit Data</b> , input of the data to be transmitted by radio. Data from the DTE to the radio modem.
13	OUT	CTS	<b>Clear to send</b> , Handshake signal can be used to drive external interface converters.
14	IN	DTR	<b>Data Terminal Ready</b> , modem ON/OFF, active low. Instruction: When left unconnected the radio modem is ON (weak pull-up) *. When connected to GND or SGND the radio modem will enter the <i>Standby Mode</i> .
<b>COMMON PINS</b>			
1,3	DC	Vb	DC supply voltage, positive
2,4	DC	GND	DC return, negative DC input, internally connected to SGND
5	IN	NC	Do not connect
6	IN	SHDN	Modem power down, active low, weak pull-up. *
7	IN	PROG	Operational mode, active low, weak pull-up. * Instruction: When the connected to ground (GND/SGND), the radio modem enters the <i>Programming Mode</i> which is for changing the settings of the radio modem (i.e. configuration, set-up). If the PROG-line is not connected, the radio modem will enter the <i>Data Transfer Mode</i> , in which data can be transmitted and received. The <i>Programming Mode</i> is used only when installing a radio modem and changing the parameters of a modem.
8	OUT	VDD_ AUX	Regulated 5.5 V (5.3...5.7 V) DC output. Max load 100 mA. Intended to power external devices made by SATEL (e.g RS-LINK, MINI-LINK).
15	-	NC	Not connected
16	IN	SGND	Signal ground, internally connected to GND.

\*) **NOTE!** For cables > 1m the DTR should not be left unconnected in order to prevent disturbances from pulling DTR low and thus shutting down the modem.



### **2.1.2 RS-232 interface**

RS-232 standard defines the method of serial data transfer between a computer and its peripherals. The definition includes both the interface type and signal levels. Most computers and peripherals contain one or more RS-232 type serial ports. The RS-232 standard uses transmission lines, in which each single signal line level is referenced to a common ground level. RS-232 has been designed to be use in serial transfer of data in cases where the distance between communicating equipment is less than 15 m. The otherwise useful RS-232 standard is applied in a multitude of slightly differing ways (e.g. different pin configurations) and for this reason different computers and peripherals are not necessarily directly compatible with each other.

**NOTE!**

When connecting equipment using RS-232 make sure that the equipment are to be connected together or share the same ground potential (or that the signal ground of one and/or both of the devices are floating). Major differences in ground potentials will lead to large currents flowing in the GND wire of the RS-232 interface which might lead to malfunctions or damage to the connected devices!

## 3 RF Interface

The antenna connector type is a SMA (female) with an impedance of 50 ohm.

The user can change the frequency of the radio modem within the 868-870 MHz frequency band.

The raw data rate of the radio interface is always fixed (9600 bps) irrespective of the data speed of the serial interface. In cases where the terminal speed exceeds the throughput of the radio interface (approximately 9600 bps), the modem will buffer the data in order to prevent data loss.

### 3.1 Transmitter

The output power of the transmitter is adjustable. The greatest allowable power, which must not be exceeded, depends on the selected sub-band and the limits set by local authorities. The output power of the transmitter should be set to the smallest possible level which still ensures error free connections under variable conditions. Large output power levels using short connection distances can in the worst case cause disturbances to the overall operation of the system.

OUTPUT POWER	dBm
5 mW	+ 7
10 mW	+ 10
20 mW	+ 13
50 mW	+ 17
100 mW	+ 20
250 mW (only 1870E)	+ 24
500 mW (only 1870E)	+ 27

Possible output power settings of the SATELLINE-1870 radio modem.

#### **NOTE!**

Setting the radio data modem output power level to levels exceeding regulations set forth by local authorities is strictly forbidden. The setting and/or the use of non-approved power levels may lead to prosecution. SATEL is not responsible for any illegal use of its radio equipment, and is not responsible in any way for any claims or penalties arising from the operation of its radio equipment in ways contradictory to local regulations and/or requirements and/or laws.

### 3.2 Receiver

The Signal Threshold Level setting of the receiver determines a level, above which the search for the actual data transfer signal is active. It is usually recommendable to use a value of  $-113$  dBm. If the Signal Threshold Level setting is set too low [the CD-LED is constantly ON (orange)], it is possible that the receiver is trying to synchronise itself with noise. In this case the actual data transmission might remain undetected.

If the RSSI-threshold is set too high weak data transmissions will be rejected, although they would be otherwise acceptable.

The RSSI-threshold should only be changed for a reason. For example in the following cases:

- o Continuous interference is present and the desired signal is strong. In this case, the RSSI-threshold can be increased to prevent the modem from synchronising to the interfering signal and/or possible noise.
- o Maximum sensitivity should be achieved and the desired signal is very weak. In this case the sensitivity could increase by decreasing the RSSI threshold. This type of situation is usually a sign of a poorly constructed radio network / contact. Errors and momentary loss of signals can be expected in this kind of a situation. Some data might be successfully transferred.

RSSI-signal (**R**eceived **S**ignal **S**trength **I**ndicator) gives an **indication** of the strength of the received radio signal. This signal can be used to determine the approximate signal level. The RSSI is measured by the RF circuitry in the radio modem; the measured voltage is then read by the controlling processor of the radio modem. The software of the modem has a conversion table, which is used to convert the RSSI-voltage to signal strength.

The signal strength measured by the receiver has the following characteristics:

Parameter		Min	Typical	Max
RSSI range		-115dBm		-40 dBm
Absolute RSSI measurement error (compared to absolute level)				
Range:	-110 dBm ... -90 dBm	-	$\pm 1$ dBm	-
	-89 dBm ... -60 dBm	-	$\pm 2$ dBm	-
	-59 dBm ... -40 dBm		-2dB... +5dB	
Relative RSSI measurement error (error between consecutive measurements for the same modem with the same conditions )			$\pm 1$ dB	

RSSI accuracy given for temperature  $+25^{\circ}$  C.

RSSI can be read by using SL-commands, see chapter 7.2.4.

### 3.3 TX Priority ON/OFF

SATELLINE-1870 includes a TX *Priority* setting, which is used to select the priority between reception and transmission. The setting can be changed in *Programming Mode*. By default, transmission has higher priority than reception i.e. the default value is *TX Priority ON*.

*TX priority ON* means that a terminal device attached to a radio modem determines the timing of the transmission. The transmitter is switched on immediately when the terminal device is starting to output data to the modem.

If the radio is receiving data from the radio interface when data is detected on the TD line, the radio modem will stop reception and turn to the transmit state.

*TX priority OFF* means that a radio modem will not transmit unless the radio channel is free. If the radio channel is occupied when the DTE transmits data, the data will be buffered, and transmitted when the radio channel is free.

This will cause timing jitter to the system, as the moment of transmission start is not solely depending on the transmitted data. However it will decrease the probability of collisions in the air.

To toggle the *Priority* setting in the programming menu, choose selection 6:

- 6) Additional setup,
  - 5) TX priority ON/OFF

Default setting is ON.

### 3.4 Error checking

To prevent erroneous data from entering the DTE, the modem has two error checking modes:

- Datablock CRC-16 error check
- Full frame CRC-16 error check

These two modes are alternatives; only one mode can be ON, while both modes can be OFF.

#### **Function principle**

A single radio transmission consists of one frame, which consists of multiple data transfer units (DTU) of arbitrary length (1-127 bytes). Each DTU is assigned a 16-bit checksum.

The receiver will receive each DTU after which the checksum is calculated for the data content of the received DTU. The calculated checksum is compared to the received checksum. Depending on the setting *Error check* ON /OFF the receiver will do one of the following described in the following table:

ERROR CHECK MODE	ACTION
Data block CRC-16 error check= ON	<p>Each received DTU is held in a separate receive buffer until it is successfully checked for errors. An error free DTU is transmitted to the DTE-interface.</p> <p>Erroneous DTUs will be rejected.</p> <p>The detection of an error halts the reception.</p> <p>This method of error detection adds latency to the data. In the worst case the latency is 128 ms. When an error is detected the reception will be interrupted until a new transmission is detected.</p>
Full frame CRC-16 error check= OFF	
Data block CRC-16 error check= OFF	<p>The content of the entire frame is held in a separate receive buffer until it is successfully checked for errors. An error free frame is transmitted to the DTE-interface.</p> <p>Erroneous frames will be rejected.</p> <p>The detection of an error halts the reception.</p> <p>This method of error detection adds latency to the data. The added latency is proportional to the length of the frame. If the transmitting modems transmit a consecutive string of data containing 200 characters (9600 bps), the added latency will be 200 ms.</p> <p>When using terminal speeds 4800 or less, the proportion of added latency will become somewhat distorted, but a good approximation is that the added latency is equal to the length in time of the transmitted data string.</p>
Full frame CRC-16 error check= ON	
Data block CRC-16 error check= OFF	<p>Each received DTU is directly transmitted to the DTE-interface and error checking is done when the checksum for the received DTU is received. If the checksum comparison detects an error, the erroneous data might already have been transmitted further to the DTE and can thus not be stopped.</p> <p>The detection of an error halts the reception; this is done to prevent further erroneous data from reaching the DTE.</p>
Full frame CRC-16 error check= OFF	

Switching the error checking ON in the *Programming Mode*, choose selection 6:

- ```
6) Additional setup,
   3) Datablock CRC-16 Error check           ON/OFF
   8) Full frame CRC Error check            ON/OFF
```

**NOTE!**

When using industrial protocols like MODBUS-RTU, which are sensitive to inter character delay, it is recommended to use FULL FRAME CRC-16 error check, this mode will strip the inter character delays from the data stream which the receiving modem sends to the DTE port. However, the added latency needs to be encountered for in the parameters of the MODBUS master communication parameters.

### **3.5 Limit radio frame length**

Normally the length of a single transmission is not limited by the modem. In normal operation a transmission is ended when:

- o The TX buffer is empty and a Brake (normally 3 RS-232 data bytes) on the RS-232 TD line has been detected.
- o The buffer overflows.

In theory, when using 19200 or 9600 transfer speed the transmission can be of infinite length. The probability of such a situation increases if hardware handshaking is used.

The frame synchronisation sequence and the frame identifiers (frame type, addresses etc.) are transmitted only in the beginning of each frame (each radio transmission). These signals might seem redundant to the user, but they are necessary for the receiver to be able to receive the transmitted frame. Thus if the receiver momentarily loses the reception of the transmitted frame it will not be able to synchronise to the same frame again. The receiver will stop reception and start looking for the beginning of the next frame, which in theory then might never come.

To overcome this problem the modem is fitted with the "limit radio frame length" setting. Setting this function to ON will cause the transmitting modem to limit the frame length to approximately 1kB. When this limit is reached the modem will end the current frame properly and start the transmission of a new frame.

The downside of this function is that it is not possible to transmit data during the transmission of the synchronisation pattern. During actual reception this property will appear as a 20 ms (approximate value) pause in the reception of data. This might cause errors in systems, which are based on the monitoring of the pauses between individual transmitted data (packets).

## 4 USER INTERFACE

### 4.1 LED-indicators

There are five (5) LED-indicators on the front panel of the radio modem and they give an indication of the status of the serial port and the radio interface:

| LED | Indication      | OFF       | Red          | Orange | Green     |
|-----|-----------------|-----------|--------------|--------|-----------|
| CD  | Radio status    | No signal | Transmission | Noise  | Reception |
| RD  | RD-line status  | No data   | Data         |        |           |
| TD  | TD-line status  | No data   | Data         |        |           |
| CTS | CTS-line status | Inactive  | Active       |        |           |
| RTS | RTS-line status | Inactive  | Active       |        |           |

#### Description of the LED-indicators:

*CD* indicates the status of the radio interface. The status of the CD-signal on the serial interface may differ from the status of the LED-indicator.

*RD* indicates that the radio modem is sending data via the serial port, RD-line, pin 10.

*TD* indicates that the radio modem is receiving data via the serial port, TD-line, pin 12.

*CTS* indicates the status of DTE-connector pin 13.

*RTS* indicates the status of DTE-connector pin 11.

Special LED-sequences are used when any tests are enabled or when the modem is in the error state.

### 4.2 Self diagnostics

The internal CPU of the modem monitors the operation of the radio modem. The following functions are included in the modems self diagnostics:

- RF-output power control loop
- Status of various software processes
- The content of the RAM
- The content of the ROM
- Other internal functions

When the self-diagnostic function of the modem discovers an error in any of the above-mentioned functions the modem will go to the *ERROR*-state.

In the *ERROR*-state the modem does not transfer data, transmission and reception is disabled. In the error state the LED-indicators blink in the following sequence:

- All LEDs ON -> All LEDs OFF -> ERROR code -> All LEDs off

This cycle repeats for approximately 10 seconds and is then followed by a reset.

If the error was of a momentary nature, for example caused by some external interference (power dips, lightning etc.) the modem will return to its power-on state.

If the error was caused by a permanent fault in the modem or a permanent fault in the surrounding conditions (erroneous supply voltage, continuous external transients etc.) the modem will most likely return to the same error state after the reset.

The following table describes how the ERROR-code part of the ERROR LED-sequence should be interpreted.

| LED | Internal RAM error | RF-output power adjust error | HW-error | SW-error |
|-----|--------------------|------------------------------|----------|----------|
| CD  | Green              | Green                        | Green    | Green    |
| RD  | OFF                | OFF                          | OFF      | OFF      |
| TD  | OFF                | OFF                          | OFF      | Red      |
| CTS | OFF                | Red                          | Red      | OFF      |
| RTS | Red                | OFF                          | Red      | OFF      |

### 4.3 Programming Mode

The settings of SATELLINE-1870 are fully configurable in the *Programming Mode* by using a suitable terminal program.

The radio modem will shift into the *Programming Mode* by connecting the DIN41651-connector pin 7 to ground (GND). When using the *Programming Mode*, the radio modem will use the serial port, with settings 9600 bps, N, 8, 1 (data transfer speed 9600 bps, no parity, 8 data bits and 1 stop bit). Programming mode can be activated also by using an SL-command, see chapter 7.2.5.

#### 4.3.1 Changing the settings

- o Connect cables (RS-232 cable to PC COM-port, power supply cable to power supply).
- o Switch on the PC and start the *SaTerm 4* program (or other terminal program).
- o Open a terminal window and select with the right mouse button a menu and choose "Prog Settings" (in case you are using some other terminal program, set the serial port parameters as follows: 9600 bit/s, 8 data bits, no parity, 1 stop bit, which is always default in *Programming Mode*).



- o Connect PROG-pin to ground.
- o Make desired changes to the settings.
- o Save changes by pressing "E" in the main menu. If you don't want to save changes, press "Q".
- o Disconnect PROG-pin from ground, the radio modem will now reset the internal CPU and return to the *Data Transfer Mode* with the programmed settings.

```
-----  
***** SATEL, SATELLINE - 1870(E) *****  
  
SW Version x.yz HW Version uCTC8G.0 Serial no. 0123456789  
-----  
Current settings  
-----  
1) Radio frequency      869.4125 MHz, Band 6 (869.4000-869.6500, 500 mW)  
2) Radio settings      TX power 500 mW, RSSI-threshold -113 dBm, TX delay 0 ms  
3) Addressing          RX address ON/0000/0000, TX address OFF/0000/0000  
                      Protocol 1: OFF, Start char. 00, Offset 0, 1 BYTE  
                      Protocol 2: OFF, Start char. 00, Offset 0, 1 BYTE  
                      Hop-count 15, TX address bitmapping OFF  
                      RX address masking OFF, Repeater address bypassing OFF  
                      Subnet mask 1 0000, Subnet mask 2 0000  
4) Serial port         9600 bit/s, 8 bit data, None parity, 1 stop bit  
                      Pause length 3  
5) Handshaking         CTS Clear to send, RTS Ignored  
6) Additional setup    Repeater OFF, SL ON, Block-CRC OFF, TX priority ON,  
                      Power save OFF, Frame limit OFF, SL Extended ON  
                      Full frame CRC - OFF  
7) Tests               Test mode Inactive  
8) Restore factory settings  
  
E) EXIT and save settings  
Q) QUIT without saving  
  
Enter selection >
```

### 4.3.2 Restoring factory settings

By selecting menu selection "8", it is possible to restore the factory settings.

```
Restore factory settings  
-----  
Restore factory settings (Y/N)?
```

The factory settings are restored by selecting "Y" (YES). By pressing any other button the current settings will remain active.

## 5 TRANSPARENT DATA TRANSMISSION

### 5.1 Serial interface, data format

The SATELLINE-1870 radio modem serial interfaces use asynchronous data format. No external synchronising signal is needed, since necessary timing information is acquired from the start and stop bits transmitted before and after each data byte.

The data transfer speed of the serial interfaces can be set to 300, 600, 1200, 2400, 4800, 9600 or 19200 bps (**b**its **p**er **s**econd). The length of the data field must be 7 or 8 bits. A parity bit may also be used. The number of stop bits can be selected (1 or 2 bits).

One character to be transmitted will thus contain a start bit, the data bits (which define the actual character in question), an optional parity bit and one or two stop bits. The overall length of one character is therefore 10, 11 or 12 bits. This should be taken into account when calculating the data throughput capability of a system. In other words, also the number of start, stop and parity bits must be considered. A useful rule of thumb is that at a data transfer speed of 9600 bps, the transmission of one character will require roughly one millisecond (1 ms).

#### NOTE!

On the radio interface the radio modem uses a synchronous transfer method. The overhead of the coding etc. used on the radio interface is approximately 20 %. Thus the user gets the same transfer speed on the radio interface regardless of which character length (10,11 or 12) is used on the terminal interface.

|       |      |        |      |
|-------|------|--------|------|
| Start | Data | Parity | Stop |
|-------|------|--------|------|

Asynchronous character data format

**Example:** With an 8-bit data character length and taking for example a decimal value of "204", which corresponds to a binary value of "11001100" and with a start bit value of "0", parity bit set to either "NO" (NONE), "0" or "1" and with a stop bit value of "1", the possible combinations are listed in the table below:

| DATA FORMAT                     | CHARACTER    | CHARACTER LENGTH |
|---------------------------------|--------------|------------------|
| 8 bit, no parity, 1 stop bit    | 0110011001   | 10 bit           |
| 8 bit, even parity, 1 stop bit  | 01100110001  | 11 bit           |
| 8 bit, odd parity, 1 stop bit   | 01100110011  | 11 bit           |
| 8 bit, no parity, 2 stop bits   | 01100110011  | 11 bit           |
| 8 bit, even parity, 2 stop bits | 011001100011 | 12 bit           |
| 8 bit, odd parity, 2 stop bits  | 011001100111 | 12 bit           |

If the settings of data speed, character length, parity or the number of stop bits differ between the radio modem and the terminal, errors will be introduced into the transferred data. The serial port settings of each individual radio modem in a system can be different.

The serial port settings can be changed in the *Programming Mode*.

## 5.2 Handshake lines

When using the RS-232 serial interface, handshake signals can be used to control the data transfer. Handshake signals are used for example by the radio modem to inform the terminal that the radio channel is busy and that it cannot initiate transmission. The terminal can also control the radio modem via the RTS-line.

| Line | Direction   |
|------|-------------|
| CTS  | To terminal |
| RTS  | To modem    |

A common way of using handshake signals is to monitor the CTS-line and ignore the others. Usually the terminal is fast enough to handle the data received by the radio modem, so the use of RTS-line is not necessary.

Handshaking is not needed if the system protocol is designed to prevent collisions (data contention) by the use of polling or if the probability of collisions is small and the data loss caused by a possible collision does not cause harm to the operation of the system to which the modems are connected.

### 5.2.1 CTS-line

The CTS line has a set of user selectable modes:

#### 1) CTS-line property, Clear To Send

CTS is normally active. CTS is inactive when:

- a) The modem is receiving data from the radio interface.
- b) The modem transmit buffer is about to overflow, which happens mainly when the DTE data speed is higher than the speed of the radio interface.

#### 2) CTS-line property, TX buffer state

CTS is normally active and inactive only when:

- a) The modem transmit buffer is about to overflow, which happens mainly when the DTE data speed is higher than the speed of the radio interface.

#### 3) CTS-line property, RSSI threshold

CTS is normally active and inactive only when:

- a) The modem is receiving data from the radio interface.
- b) The modem transmit buffer is about to overflow, which happens mainly when the DTE data speed is higher than the speed of the radio interface.
- c) The measured RSSI value is higher than the set RSSI threshold.

#### **4) CTS-line property, Always ON**

The SATELLINE-1870 does not have a CD-line (carrier detect). For applications that require a CD signal the user can connect the CTS-line from the modem to the CD line in the terminal device, the CTS-line property – Always ON must then be selected.

#### **5) CTS-line property, External Converter control**

In some applications it is necessary to use an external protocol/media converter, which converts the RS232 interface of the SATELLINE-1870 to i.e. a RS-485, MBUS or a current loop signal. These converters usually need a signal, which control the operating mode of the converter (transmit enable). In such cases, the CTS line of the modem can be used to control the operation of the external converter. CTS will be active when the modem is outputting data to the RD line and inactive otherwise.

To take into account delays typical to external converter control lines, the CTS signal will go active one RS-232 frame (start bit, data bits, parity, stop bit(s)) before the data is sent out on the RD line. CTS will also remain active one RS-232 frame after the last character has been sent out from the RD line.

#### **LOOPBACK PREVENTION**

Many media converters are simple devices, which convert RS-232 to a media which uses the same wires for bidirectional data transmission (RS-485 for example). In such cases all characters sent to the external converter from the RS232 interface, usually appear as received data on the RS232 interface. This would cause the modem to send all data that it has received, or in the case of TX-priority = ON, it would stop transmission and send a single character which was looped back by the external converter. To prevent this, the modem will suppress all data on the TD line while the CTS line is keeping the external converter in transmit mode.

NOTE! Using the default configurations, the modem CTS LED usually serves as a “power indicator” as it is usually ON when no data is being received. In the case of CTS – external converter control, this is not the case. The CTS LED will be OFF, except when the modem is transmitting data to the DTE port (RD line). With this handshake mode, when no data is being transferred in either direction, no LEDs will be ON.

### 5.2.2 RTS-line

#### 1) Ignored

RTS-line status is ignored.

#### 2) Flow control

The radio modem transmits data to the terminal device only when the RTS-line is active. Non-active state of the RTS-line will force the radio modem to buffer the received data. This option is used if the terminal device is too slow to handle data received from the radio modem.

#### 3) Reception control

RTS-line controls the reception process of the radio modem. The active state of RTS-line enables reception (as normal). Non-active state of the RTS-line will interrupt the reception process immediately, even if the radio modem is receiving data from the radio interface. This option is used to force the radio modem into a state where it can either start receiving or sending.

## 5.3 Timing and delays during data transmission

When using a radio modem for data transmission, certain delays will be formed due to the use of a radio interface and from the radio modem circuitry itself. These delays are formed when the radio modem switches from *Standby Mode* to *Data Transfer Mode* and during reception and transmission of data.

### 5.3.1 Data buffering in the radio data modem

Whenever the radio modem is in *Data Transfer Mode* it monitors both the radio channel and the serial interface. At the beginning of each transmission a synchronisation signal is transmitted and this signal is detected by the receiving radio modem, which then switches into receive mode.

During the transmission of the synchronisation signal the radio modem buffers data into its memory. Transmission ends when the transmission buffer is empty and a pause is detected in the data sent by the terminal device. When the serial interface speed is slower than the throughput of the radio interface, the internal transmit buffer memory cannot overflow. The maximum size of the transmit buffer memory is one kilobyte (1 kB). If the terminal device does not follow the status of the CTS-line and transmits too much data to the radio modem, the buffer overflow, upon which will be emptied and the transmission is restarted.

In the receive mode the buffer works principally in the above described way thus evening out differences in data transfer speeds. If the terminal device transmits data to a radio modem in receive mode, the data will go into the transmit buffer memory. Depending on the TX priority setting the modem will do one of the following:

- a) TX-priority ON, immediately start transmitting the data sent by the DTE or

- b) TX-priority OFF, continue in receive mode and buffer the data sent by the DTE. The buffered data will be transmitted when the radio channel is free (when the modem is not in the receive state).

### **5.3.2 Pause length**

The modem recognises a pause on the serial line (a pause is defined as a time with no state changes on the RS-232 interface TD-line). The pause detection is used as criteria for:

- a) End of radio transmission (in transmitting modem)

When the transmit buffer is empty and a break is detected, the modem stops the transmission and will then change the radio to the receive mode

- b) SL-command recognition

For a SL-command to be valid, a pause must be detected before the actual "SL..." character string.

- c) User address recognition

In order for the start character to be detected, a pause must precede it in transmission

Traditionally, in asynchronous data communication, pauses have been used as means to separate serial messages from each other. However, the use of non-real-time operating systems (frequently used on PC-type hardware) has changed this tradition by adding random pauses in the asynchronous data stream.

In practice these pauses are caused by the non-real-time operating systems, which cannot service the hardware UART properly when performing other tasks (other applications or tasks of the operating system itself).

The pauses described above are typically beyond 100 ms. If such a pause happens to occur in the middle of a user message, the radio modem transmits the message as two separate radio transmissions.

This will cause problems in at least two ways:

- 1) The inter character delay will increase by at least the time of the modem transfer delay
- 2) The probability of collisions on the radio-path will increase (when using TX priority = ON)  
This will be especially harmful for repeater chains

The following examples demonstrates how the pauses will effect the inter character delay.

All modems have priority TX= OFF, and TX delay 0.

Example 1. Two modems, TX priority = OFF, Pause Length = 3  
Application ie. PPP communication

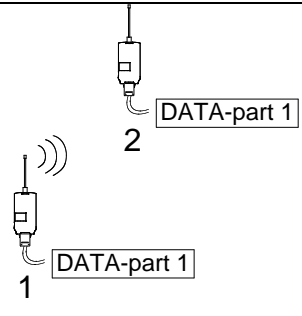
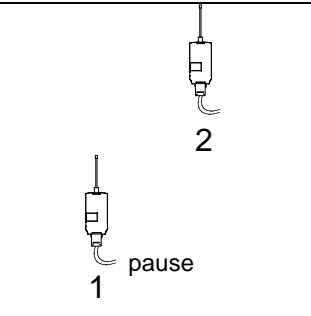
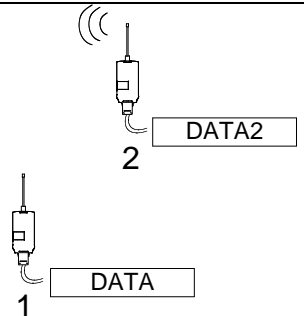
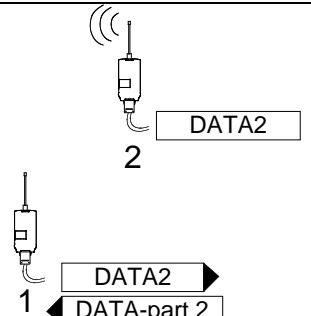
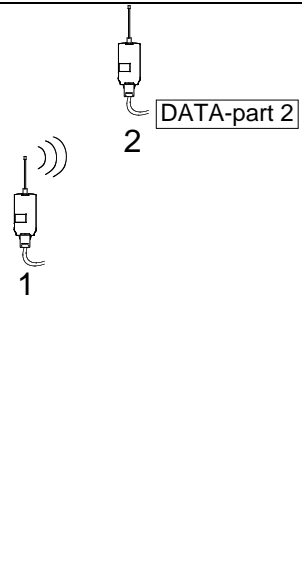
|                                                                                                               |                                                                                                                                                                                                                                                                                                                                                                                                                                                                                                                                                                                                                                |                                                                                                                                                                                                                                                                      |                                                                                                                                                                                                                                                       |
|---------------------------------------------------------------------------------------------------------------|--------------------------------------------------------------------------------------------------------------------------------------------------------------------------------------------------------------------------------------------------------------------------------------------------------------------------------------------------------------------------------------------------------------------------------------------------------------------------------------------------------------------------------------------------------------------------------------------------------------------------------|----------------------------------------------------------------------------------------------------------------------------------------------------------------------------------------------------------------------------------------------------------------------|-------------------------------------------------------------------------------------------------------------------------------------------------------------------------------------------------------------------------------------------------------|
|                              |                                                                                                                                                                                                                                                                                                                                                                                                                                                                                                                                               |                                                                                                                                                                                    |                                                                                                                                                                    |
| <p>The DTE of modem 1 starts to transmit a serial message. Modem 1 is transmitting, modem 2 is receiving.</p> | <p>The DTE of modem 1 makes pauses in the serial stream (the pause is &gt; the pause length setting).<br/><br/>Modem 1 will stop transmitting when a pause is detected and the TX buffer is empty.</p>                                                                                                                                                                                                                                                                                                                                                                                                                         | <p>The DTE of modem 2 sends a message. This might be a reply to the partial received message (ACK, NACK response) or other transmission.<br/><br/>Modem 2 will detect that the radio channel is free and starts transmitting, modem 1 receives the transmission.</p> | <p>Modem 2 is still transmitting. Modem 1 is receiving.<br/>At the same time the DTE of modem 1 will start transmitting the second part of the message (DATA-part 2)<br/>Modem 1 cannot start the RF transmission because the RF channel is busy.</p> |
|                            | <p>Modem 2 transmission stops.<br/>Modem 1 will detect that the channel is free.<br/>Modem 1 starts transmission of the buffered second part of the serial message (DATA-part 2).<br/>Modem 2 will receive the transmission.</p> <p>The DTE connected to modem 2 will receive both parts of the DATA message; however there will be a significant delay between part 1 and part 2.<br/>The delay will be caused by:<br/>1) DATA 2 transfer time<br/>2) Modem transfer delay</p> <p>If data 2 is 50 characters, and the serial parameters are 9600,8,N,1 the delay will be approximately <math>70 + 70 + 50 = 190</math> ms</p> |                                                                                                                                                                                                                                                                      |                                                                                                                                                                                                                                                       |

Example 2. Two modems, TX priority = OFF, Pause Length = 120  
Application ie. PPP communication.

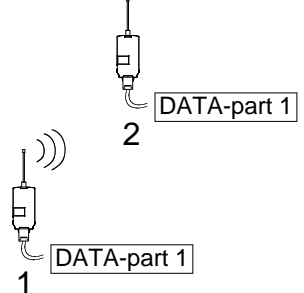
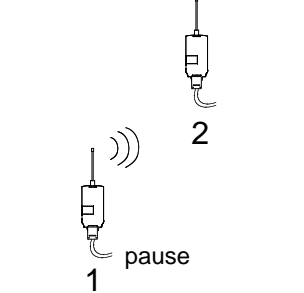
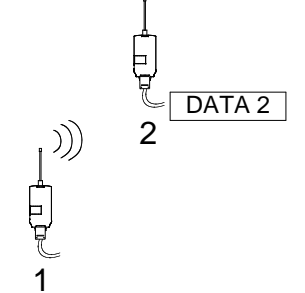
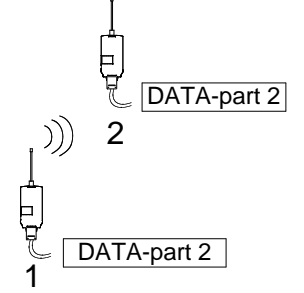
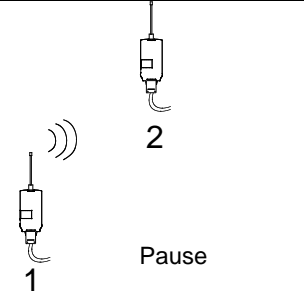
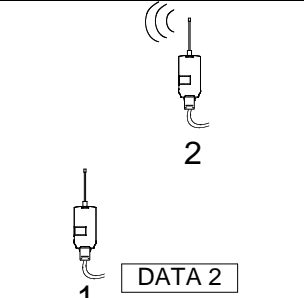
|                                                                                                                                                              |                                                                                                                                                                                              |                                                                                                                                                                                                                                       |                                                                                                                       |
|--------------------------------------------------------------------------------------------------------------------------------------------------------------|----------------------------------------------------------------------------------------------------------------------------------------------------------------------------------------------|---------------------------------------------------------------------------------------------------------------------------------------------------------------------------------------------------------------------------------------|-----------------------------------------------------------------------------------------------------------------------|
|                                                                             |                                                                                                             |                                                                                                                                                     |                                    |
| <p>The DTE of modem 1 starts to transmit a serial message. Modem 1 starts transmission, modem 2 will receive the message.</p>                                | <p>The DTE of modem 1 makes a pause in the serial stream. Modem 1 will continue transmitting because the pause &lt; the pause length setting, a pause is not detected.</p>                   | <p>The DTE of modem 2 sends a message. Might be a reply to the partial message (NACK response or ARQ-message) or other transmission.</p> <p>Modem 2 will detect that the RF channel is busy, and will not start the transmission.</p> | <p>The DTE of modem 1 starts to transmit the second part of a serial message. Modem 1 continues the transmission.</p> |
|                                                                           |                                                                                                           |                                                                                                                                                                                                                                       |                                                                                                                       |
| <p>Modem 1 stops transmission when the tx buffer is empty and a pause that is longer than the pause length setting has been detected on the serial line.</p> | <p>Modem 2 senses that the radio channel is free and starts transmitting the message buffered earlier (DATA 2).</p> <p>Notice how no inter character delay has been added by the modems.</p> |                                                                                                                                                                                                                                       |                                                                                                                       |

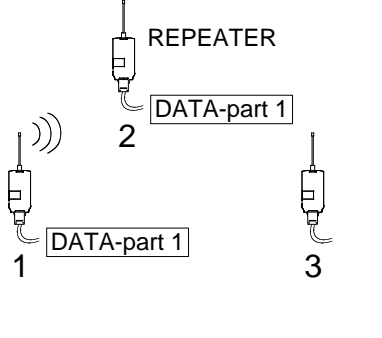
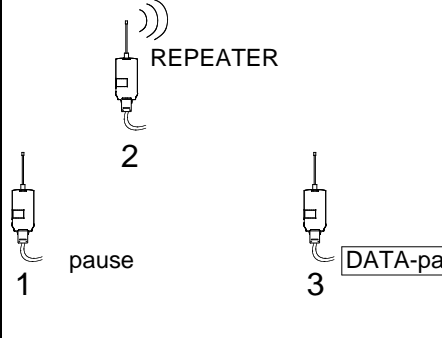
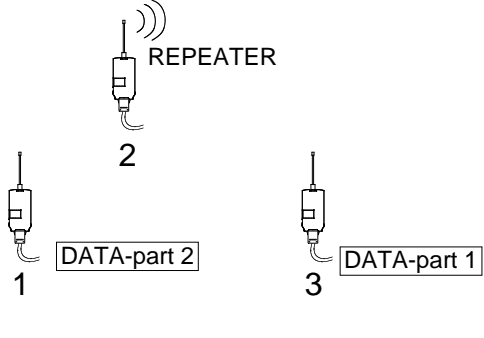
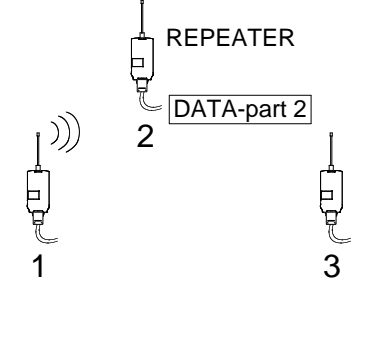
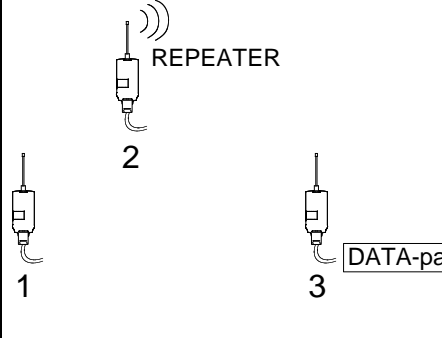

Example 3. Three modems, modem 2 is a repeater.  
All modems have the following settings: TX priority = OFF, Pause Length = 120  
Application ie. PPP communication.

|                                                                                                                                                                    |                                                                                                                                                                                                     |                                                                                                                                                                                                                                                           |
|--------------------------------------------------------------------------------------------------------------------------------------------------------------------|-----------------------------------------------------------------------------------------------------------------------------------------------------------------------------------------------------|-----------------------------------------------------------------------------------------------------------------------------------------------------------------------------------------------------------------------------------------------------------|
|                                                                                   |                                                                                                                    |                                                                                                                                                                         |
| <p>The DTE of modem 1 starts to transmit the first part of the serial message. Modem 1 starts transmission, modem 2 will receive the message.</p>                  | <p>Modem 1 detects a pause and stops the transmission (pause &gt; pause length setting). Modem 2 will start repeating the message received from modem 1. Modem 3 receives the repeated message.</p> | <p>The DTE of modem 1 starts to transmit the second part of a serial message. Modem 2 is still repeating the first part of the message. Modem 1 will not start transmission because it detects that the RF channel is busy (Modem 2 is transmitting).</p> |
|                                                                                 |                                                                                                                  |                                                                                                                                                                                                                                                           |
| <p>Modem 2 transmission stop. Modem 1 starts transmitting the buffered second part of the serial message. Modem 2 will receive the second part of the message.</p> | <p>Modem 2 will start repeating the message received from modem 1. Modem 3 receives the repeated message</p>                                                                                        |                                                                                                                                                                                                                                                           |

In this example DTE 3 will experience a very long significant delay between DATA-part 1 and DATA-part 2. Note that the DTE connected to modem 3 will experience this delay as an inter character delay.

The delay between DATA part 1 and DATA part 2 will be =>

1) the transfer delay from modem 1 to modem 2

- 2) the length of the second part of the message (because of the store / forward nature of the repeater)
- 3) the transfer delay from modem 2 to modem 3.

Assume that the entire message is 100 characters, and transfer speed is 9600.  
Data 1 is 40 characters, and data 2 is 60 characters

The delay between data 1 and data 2 at the output of modem 3 will thus be = 70 ms + 60 ms + 70 ms = 200 ms.

Example 4. Three modems, modem 2 is a repeater.

All modems have the following settings: TX priority = OFF, Pause Length = 120

Application ie. PPP communication.

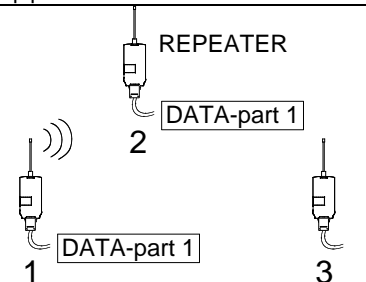
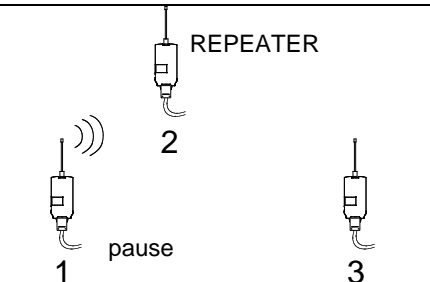
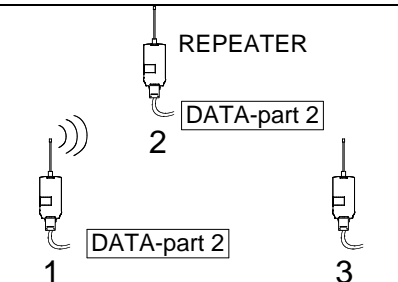
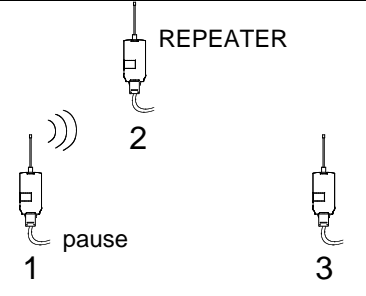
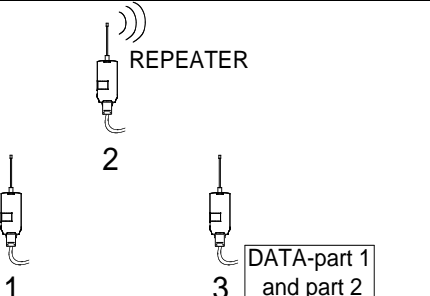
|                                                                                                                                                 |                                                                                                                                                                                                                              |                                                                                                                                                            |
|-------------------------------------------------------------------------------------------------------------------------------------------------|------------------------------------------------------------------------------------------------------------------------------------------------------------------------------------------------------------------------------|------------------------------------------------------------------------------------------------------------------------------------------------------------|
|                                                                |                                                                                                                                             |                                                                         |
| <p>The DTE of modem 1 starts to transmit the first part of a serial message. Modem 1 starts transmission, modem 2 will receive the message.</p> | <p>Modem 1 continues transmission, because the pause is &lt; the pause length setting.</p>                                                                                                                                   | <p>Modem 1 continues the transmission and transmits the second part of the serial message. Modem 2 will receive the second part of the serial message.</p> |
|                                                              |                                                                                                                                           |                                                                                                                                                            |
| <p>Modem 1 stops the transmission when a pause of sufficient length has been detected (pause &gt; pause length setting).</p>                    | <p>Modem 2 will start repeating the entire message received from modem 1 (data part1 and part2)<br/>Modem 3 receives the repeated message</p> <p>The DTE 3 will not experience delay between DATA-part1 and DATA-part 2.</p> |                                                                                                                                                            |

NOTE ! It is not always obvious to the user what type of operating system the terminal device is using. Many modern devices (ie. manufacturing or measuring equipment) use Microsoft Windows though the user is often not aware of this

NOTE ! As the pause is used as a criteria for stopping the transmission, setting the pause length to ie. 100 ms will cause the transmitter to be active also 100 ms after the data has already been sent.

If this is not acceptable then a TX delay setting must be used to control each string so that it will end up in the same frame. Using TX delay is however, dependent on the length of the string used. If various string lengths are used the TX delay has to be set according to the longest string. Using TX delay will also add latency to the data transmission. Using pause length will not add latency but will add time to the round trip delay; this is due to the fact that the radio channel is occupied for the time of the pause length after each transmission (the time it takes to detect a pause).

### **Adjusting the pause length**

The pause length can be adjusted from the programming menu, the parameter can have any value between 1 and 255, where 1 = the time for the transfer of 1 byte on the serial line (including the start, stop and possible parity bits), for example:

9600 bps, no parity, 8 data bits, 1 stop bit = 10 bits = 1,04 ms.

9600 bps, even parity, 8 data bits, 1 stop bit = 11 bits = 1,146 ms.

The following example shows how the modem behaves when detecting a pause, and how to correct the problems cause by non-real-time operating systems.

Definitions:

Inter character delay:

The amount of time from the stop bit from the previous byte to the start bit of the next byte on an asynchronous transfer line (ie. RS-232)

Transfer delay (latency):

The transfer delay caused by the modem, from the start bit of the first byte on the TD line of the transmitting modem to the start bit of the first byte on the RD line of the receiving modem.

The following table demonstrates the affect of the pause length setting to the modem operation when there is a pause in the middle of the user data transmission.

Notice how the data is split into two separate RF transmissions if the pause length setting is shorter than the maximum pause (inter character delay) of the transmitting DTE.

|                                                                                                                                                                                                                                                                                                                                                                                                                            |                                                               |                                                                                                                                                                                                                                                                                                                                                                                                                                                      |  |
|----------------------------------------------------------------------------------------------------------------------------------------------------------------------------------------------------------------------------------------------------------------------------------------------------------------------------------------------------------------------------------------------------------------------------|---------------------------------------------------------------|------------------------------------------------------------------------------------------------------------------------------------------------------------------------------------------------------------------------------------------------------------------------------------------------------------------------------------------------------------------------------------------------------------------------------------------------------|--|
| <p>The pause length (defined by the pause length setting)</p> <p style="text-align: center;">&lt;</p> <p style="text-align: center;">the pause in the middle of the user data field.</p>                                                                                                                                                                                                                                   |                                                               | <p>The pause length (defined by the pause length setting)</p> <p style="text-align: center;">&gt;</p> <p style="text-align: center;">the pause in the middle of the user data field.</p>                                                                                                                                                                                                                                                             |  |
| <p>Timing diagram for pause length &lt;: Shows Modem 1 TD LINE and Modem 2 RD LINE with two DATA blocks. Transfer delay <math>t_{TD}</math> and inter-character delay <math>t_{ICD}</math> are marked. A pause in data is shown between the two DATA blocks, caused by the operating system. Modem 1 ACTION shows RX and TX blocks. TX buffer is empty, break detected. New data is detected, transmission is started.</p> |                                                               | <p>Timing diagram for pause length &gt;: Shows Modem 1 TD LINE and Modem 2 RD LINE with two DATA blocks. Transfer delay <math>t_{TD}</math> and inter-character delay <math>t_{ICD}</math> are marked. A pause in data is shown between the two DATA blocks, caused by the operating system. Modem 1 ACTION shows RX, TX, TX (idle), TX, TX (idle) blocks. TX buffer is empty, break not detected. New data is detected, transmission continues.</p> |  |
| Symbol                                                                                                                                                                                                                                                                                                                                                                                                                     | Description                                                   |                                                                                                                                                                                                                                                                                                                                                                                                                                                      |  |
| $T_{TD}$                                                                                                                                                                                                                                                                                                                                                                                                                   | Transfer delay (caused by the modem)                          |                                                                                                                                                                                                                                                                                                                                                                                                                                                      |  |
| $T_{ICD}$                                                                                                                                                                                                                                                                                                                                                                                                                  | Inter character delay (caused by the transmitting DTE)        |                                                                                                                                                                                                                                                                                                                                                                                                                                                      |  |
| $T_{PL}$                                                                                                                                                                                                                                                                                                                                                                                                                   | A time corresponding to the pause length setting of the modem |                                                                                                                                                                                                                                                                                                                                                                                                                                                      |  |
| $T_{ICD} + T_{TD}$                                                                                                                                                                                                                                                                                                                                                                                                         | The sum of inter character delay and the transfer delay       |                                                                                                                                                                                                                                                                                                                                                                                                                                                      |  |
| <p>NOTE !</p> <p>This delay varies depending on handshaking, error correction, error checking etc. Systems should not be constructed on the assumption that delays are copied from the transmitting modem to the receiving modem.</p>                                                                                                                                                                                      |                                                               |                                                                                                                                                                                                                                                                                                                                                                                                                                                      |  |

**NOTE!**

When using for example Microsoft Windows NT or 2000, inter character delays of over 120 ms have been measured!

The pause length setting is implemented in sw 1.28 and beyond.

In previous software versions (sw 1.26) the pause length setting was labelled as a "break length", and it was used only if the modem was configured to read the address from the user data.

**5.3.3 TX-delay**

The radio modem can be configured to delay the beginning of a radio transmission by 0-65535 ms (65.5 s). This function can be used to prevent packet contention in a system, where all substations would otherwise answer a poll of a base-station simultaneously. During this delay data sent by the terminal device to the modem is buffered. If this function is not needed, the delay time should be set to 0 ms.

**NOTE!**

The TX-delay resolution is 5 ms, the configuration software always rounds the entered value to the closest lower multiple of 5. For example 333 ms is converted to 330 ms, 336 ms is converted to 335 ms.

TX-delay, when using *TX priority ON*:

The TX-delay counter is started when the modem receives a byte from the radio modem. Transmission will start when the timer has reached the set value. Any data transmitted by the DTE to the modem will be buffered while the TX-delay counter is counting.

The modem will not receive any data from the air interface while the TX-delay timer is counting.

Example 1.

A system with 3 stations within the same RF coverage (all stations are able to receive the other stations transmissions).

Each modem uses *TX priority ON*, each modem has TX start delay=0 ms.

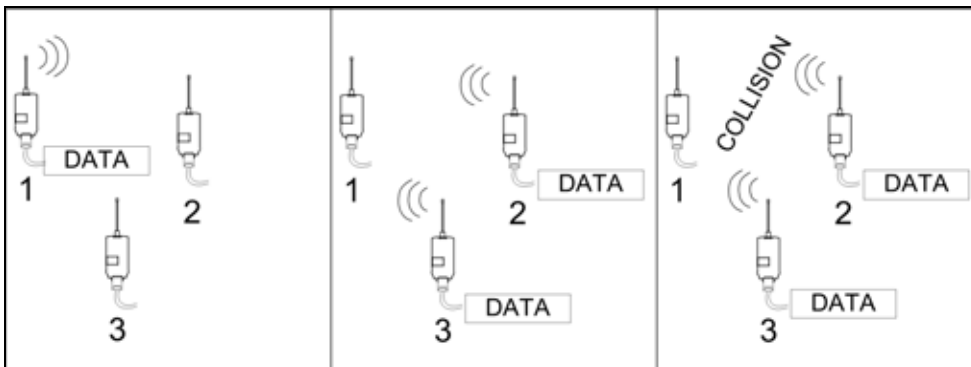

Modem 1 is transmitting, i.e. sending a group poll requiring the terminals connected to modems 2 and 3 to answer.

Modem 1 transmission stops. The terminals connected to modems 2 and 3 answer the group poll.

Modems 2 and 3 transmit simultaneously. The transmissions collide in the air. Modem 1 will not receive either data correctly.

Example 2.

A system with 3 stations within the same RF coverage (all stations are able to receive the other stations transmissions). Each modem uses *TX priority ON*, Modem 1 start delay=0 ms, Modem 2 TX start delay=60 ms, Modem 3 TX start delay = 120 ms.

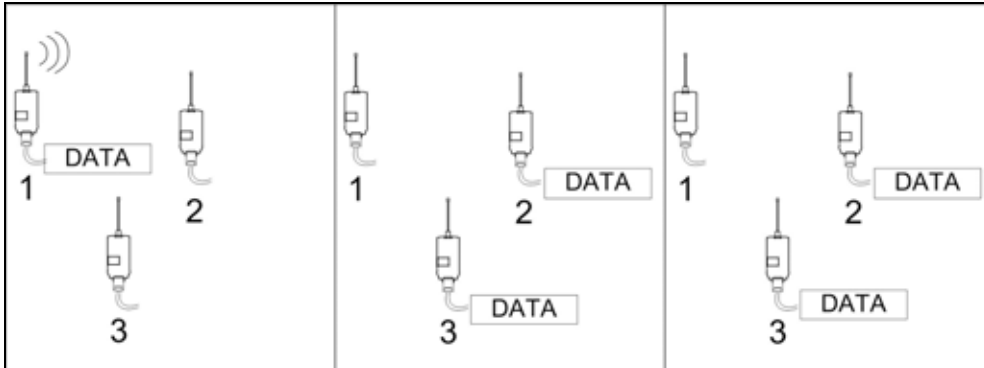

Modem 1 is transmitting, i.e. sending a group poll requiring the terminals connected to modems 2 and 3 to answer.

Modem 1 transmission stops. The terminals connected to modems 2 and 3 answers the group poll.

Modems 2 and 3 start their TX delay timer.

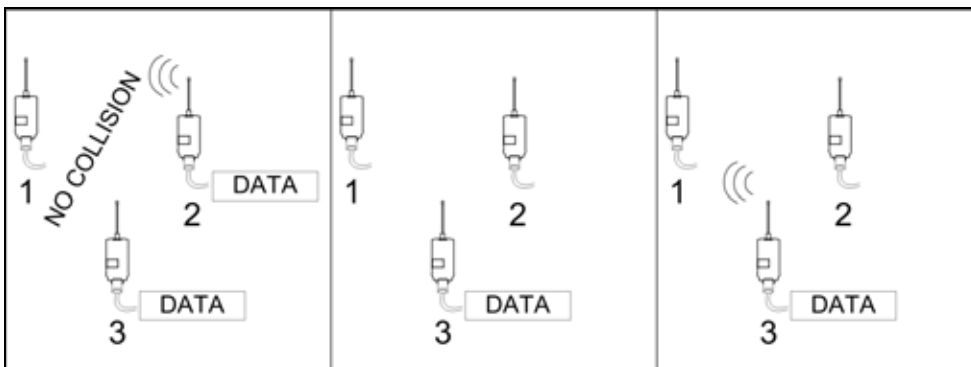

Modem 2 TX delay timer reaches the set value. Modem 2 will start transmission. Modem 3 is still waiting for its TX delay timer to reach the set value.

Modem 2 transmission stops. Modem 3 waits for its TX delay timer to reach the set value.

Modem 3 TX start delay is reached. Modem 3 starts the transmission.

*RX-delay*, when using *TX priority OFF*:

The TX-delay counter is started when the modem receives a byte from the radio modem. The timer will be reset and stopped if the RF channel is occupied. The timer will start again when the RF channel is free.

This function can be used to prevent collisions in systems where all nodes can initiate transmissions (i.e. "multimaster", or distributed systems).

Example 3.

A system with 3 stations within the same RF coverage (all stations are able to receive the other stations transmissions).

Each modem uses *TX priority OFF*, each modem has TX start delay=0 ms.

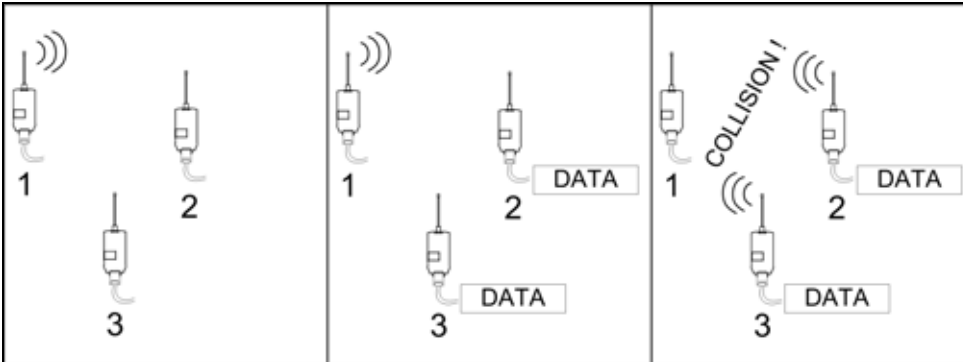

Modem 1 is transmitting, modems 2 and 3 are receiving.

Modem 1 is transmitting, modems 2 and 3 are receiving. The terminals of modems 2 and 3 are transmitting.

Modem 1 stops transmission, modems 2 and 3 have equal TX start delay settings. The transmissions collide in the air. Modem 1 will not receive either transmission.

Example 4.

A system with 3 stations within the same RF coverage (all stations are able to receive the other stations transmissions).

Each modem uses *TX priority OFF*, Modem 1 start delay=0 ms, Modem 2 TX start delay=x ms, Modem 3 TX start delay = x ms + 70 ms.

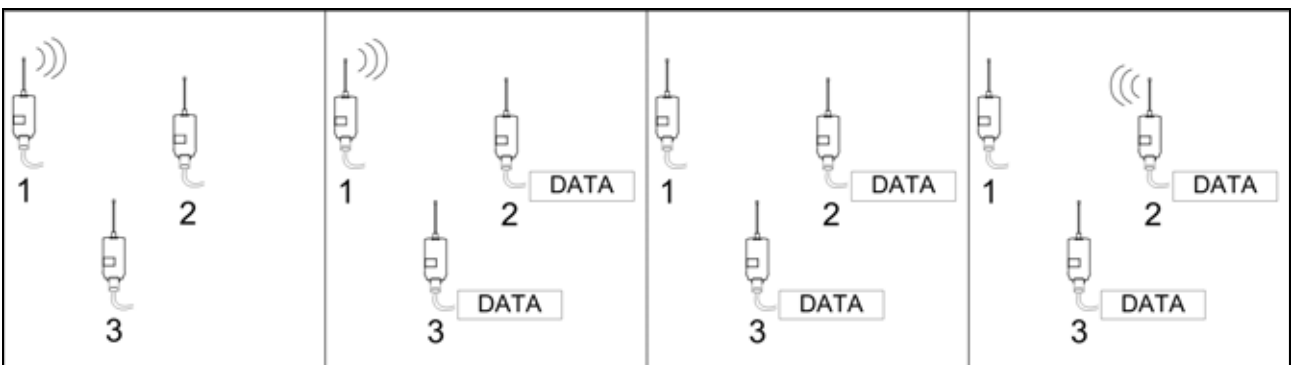

Modem 1 is transmitting, modems 2 and 3 are receiving

Modem 1 is transmitting, modems 2 and 3 are receiving. The terminals of modems 2 and 3 are transmitting.

Modem 1 transmission stops. Modems 2 and 3 start their TX start delay timer.

Modem 2 TX start delay time is reached. Modem 2 starts transmission. Modem 3 TX start delay timer is still running.

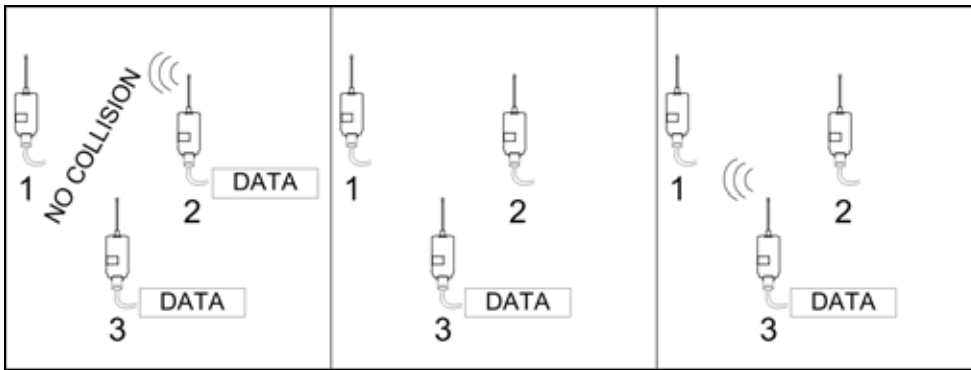

Modem 2 is transmitting, Modem 3 detects the transmission of modem 2 and resets/stops its TX start delay timer.

Modem 2 transmission stops. Modem 3 detects that the RF channel is free and starts its TX start delay timer.

Modem 3 TX start delay is reached. Modem 3 starts the transmission

**NOTE!**

The desired TX start delay is added to minimum delay of RF transmission start (approx 70 ms). Thus the latency of the data transfer is increased by the entered TX delay value.

**5.4 Tests**

The radio modem can be switched to the *Test Mode*, where it will send a test packet on the radio channel. The test packet is a normal data transmission which can be used, for example, when directing antennas during the system installation.

When the test packet transmission has been switched on and saved by using the *Programming Mode*, the transmitting radio modem needs only a power supply and an antenna.

The data throughput of the modem is roughly 9600 bps. In test cases it is therefore recommended that the serial data speed of the receiving radio modem is set to 9600 bps or higher.

When either short block or long block tests are enabled and the modem is not in the programming state the modem will run a special LED-sequence to show that the modem is performing a test. The sequence is:

RTS, CTS, TD, RD, TD, CTS, RTS, CTS etc.

The speed of the LED sequence is coded as follows:

- Long block test, slow cycle
- Short block test, fast cycle



The modem has three test modes.

#### **5.4.1 Short block test**

A single test string is sent followed by a 100 ms delay, after which the following test string is sent etc.

#### **5.4.2 Long block test**

Test strings are sent continuously for approximately 50 s followed by a 10 s delay, after which the following 50 s transmission is started etc.

#### **5.4.3 Carrier test**

The modem will send an un-modulated carrier on the desired frequency and the set output power. The carrier will remain on for the entire duration of the test. This modem can be enabled either from the programming menu or using SL commands (see chapter on SL commands). This test is intended for type approval and conformance measurement purposes.

#### **5.4.4 SATELLINE-1870 test string**

The SATELLINE-1870 uses a test string, which is constructed to serve two main purposes:

- 1) A user can monitor the quality of the received data by visually inspecting the received data stream, the packet number helps to keep track of lost messages.
- 2) A program may be constructed to read the received test strings and to calculate BER / PER (Bit Error Rate, Packet Error Rate), which can be used to evaluate the performance of the radio modem after installation.

The test string forms a simple protocol, which uses the following data fields in the indicated order:

```
$<identifier>,<null>,<packet number>,RX1:<RX1 address>,S/N:<serial number>,<text string>,CRC16,<CR><LF>
```

Example string:

```
$test1870,0,00005,RX1:0000,S/N:0123456789,This is the test line of  
Satellite - 1870,099D
```

#### **NOTE!**

The CRC used is calculated from the first character (\$) to the "," preceding the CRC.

#### **5.4.5 Monitoring the test transmission using the receiver**

The signal strength of the received test signal can be monitored using a specific SL-command (SL@R?), please ensure that SL-commands are enabled.

Error-free reception of data can be checked using a suitable terminal program.

## 6 REPEATER MODE AND ADDRESSING

Repeaters and addressing may be used to extend the coverage area of a radio modem network and to direct messages only to selected radio modems in the network.

### 6.1 Repeater

In cases where it is necessary to extend the coverage area of a radio modem network, SATELLINE-1870 radio modems can be used as repeater stations. The repeater function of SATELLINE-1870 operates in a store and forward fashion. This means that a modem acting as a repeater will receive data from the radio interface, buffer the received data (max 1 kB) and then when reception stops, the modem will re-transmit the buffered data using the same frequency as in reception.

The maximum size of a repeated data packet is 1 kB (kilobyte). The *Repeater Function* is switched on using the *Programming Mode*. In the repeater mode the radio modem will function as a totally independent unit, which means that only a power supply and a suitable antenna are needed. Other devices are not necessary.

In systems with more than one serially or parallelly chained repeaters addressing must be used to prevent having a message ending up in an infinite loop formed by repeaters and to ensure that the message finally reaches only the intended radio modem.

An example of a typical application of repeaters is shown in the picture below.

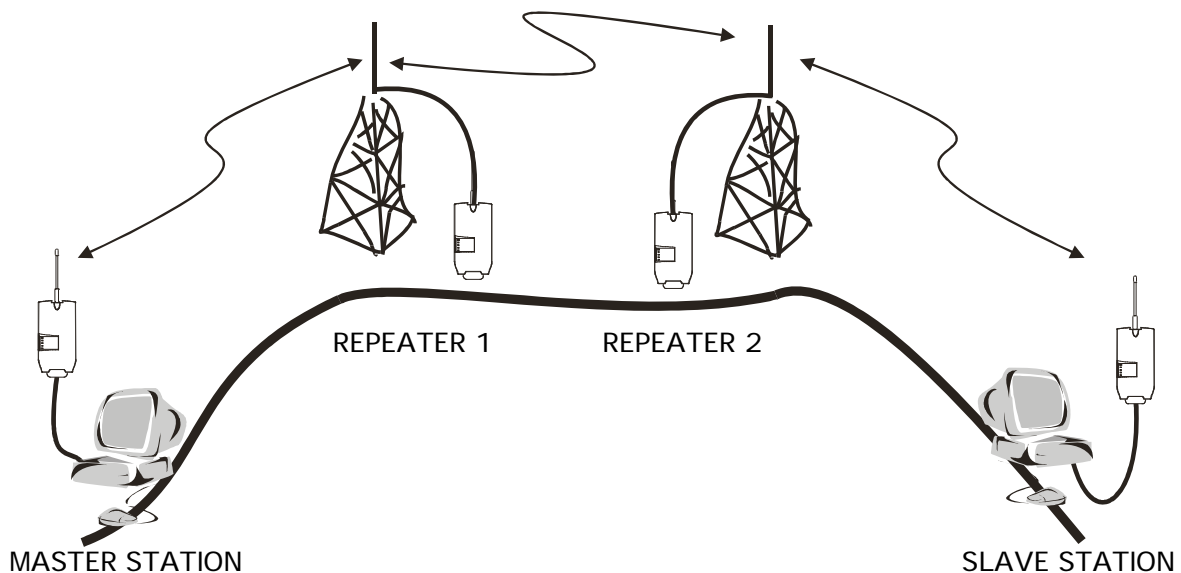

### **6.1.1 Connecting a repeater to a local DTE**

A radio modem configured as a repeater can also be used to receive and transmit data to / from a local DTE. The data received by the repeater modem will also be transmitted to the DTE interface as in normal modem operation.

#### **NOTE !**

The data latency, for a DTE connected to a modem that is configured as a repeater, depends on the repeater operations. The function as a repeater has a higher priority than the data transfer from the local DTE.

## **6.2 Addressing**

Addresses can be used to route a data message to the desired destination or to separate two parallel networks from each other. In networks with repeaters it is usually necessary to use addresses to prevent data messages from ending up in loops formed by repeaters.

The enabling of any addressing function will set the modem in addressing mode. In the addressing mode the modem will use a different, more complicated, frame structure on the radio interface. This means that:

- The latency of the modem will increase 3-4 ms (the transfer time of the address fields)
- A modem in addressing mode will receive data only from other modem in addressing mode. Other receptions will be rejected.
- When a modem is not using addresses it will not receive data from modems that do use addresses.

### **6.2.1 Primary and secondary transmit and receive addresses**

The radio modem uses separate addresses for reception and transmission. These are called transmission addresses and reception addresses. Furthermore the modem has two address sets (primary and secondary).

The addresses entered to the modem by SL-command or from the configuration menu are entered as 4 characters in hexadecimal format.

#### **6.2.1.1 Primary addresses**

##### **Transmit**

When the modem receives data from the terminal interface the data is transmitted using the primary TX address.

When the modem is configured as a repeater all data that has been received with the primary RX address will be transmitted with the primary TX address. All data originating from the local modem terminal port will also be transmitted using the primary transmit address.

## Receive

The modem receives all data using the primary receive address as a filter.

All received air interface frames which have an address matching the primary receive address of the modem will be received.

Entering 'FFFF' as a receive address will cause the modem to receive ALL frames from the air interface that are sent in the addressing mode.

When the modem is configured as a repeater all air interface frames matching the programmed primary receive address will be received. The received data will then be:

- Transmitted to the terminal interface of the modem.
- Stored in the receive buffer waiting for transmission to start.

### 6.2.1.2 Secondary addresses

#### Receive

All air interface frames matching the programmed secondary receive address will be received. The received data will then be:

- Transmitted to the terminal interface of the modem.
- Stored in the receive buffer waiting for transmission to start.

#### Transmit

When the modem is configured as a repeater, any data received (and stored) on the secondary receive address will be transmitted using the secondary transmit address once the reception has ended.

Secondary transmit address is only used in repeater applications.

If only one address pair is needed in a network, both addresses must be set the same (TX1 = TX2 and RX1 = RX2).

The address is composed of two bytes totalling 16 bits, resulting in over 65 000 different address combinations. The address is attached to the beginning of each radio transmission (radio frame). When a radio modem receives a data packet when using addressing mode, the radio modem will check the address field of the received radio frame to ensure that the address of the received packet matches either the primary or secondary address of the receiving modem.

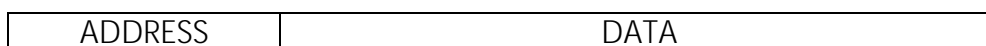

Address may be selected between 0000h...FFFFh (h = hexadecimal, corresponding decimal numbers are 0-65535).

The following examples will clarify the function of the settings.

### Transmission:

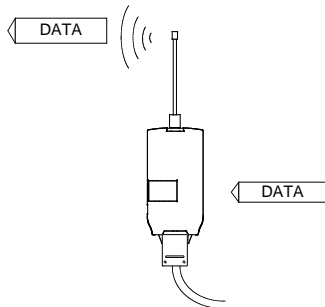

TX-addressing – OFF  
Radio modem will transmit the data packet as such.

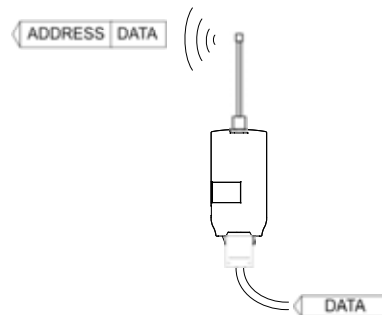

TX-addressing – ON  
The radio modem will add the primary TX address to the beginning of each frame (transmission) on the radio interface.

### Reception:

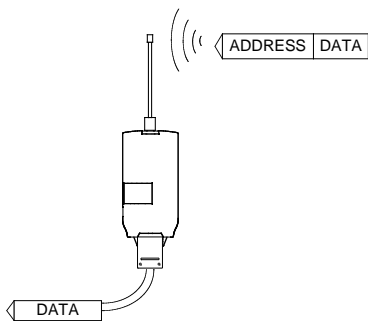

- RX-addressing – ON
- a) The primary and/or secondary address is identical to the address of the transmitting modem.
  - b) Repeater function – ON  
the secondary address is identical to the address of the transmitting modem
  - c) Primary RX address is 'FFFFh', **all** addressed frames will be received
  - d) Repeater function – ON  
Primary and or secondary address is '0000h', all addressed frames will be received (and repeated)

The radio modem will remove the address and send only the actual data to the RS-232 interface.

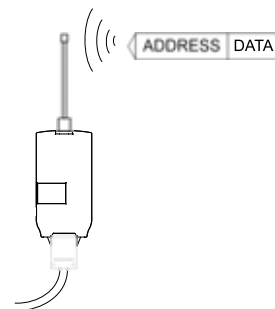

- RX-addressing – ON
- Both the primary and secondary RX addresses of the radio modem are different from the address of the received radio interface frame.

Data does not appear on the RS-232 -interface.

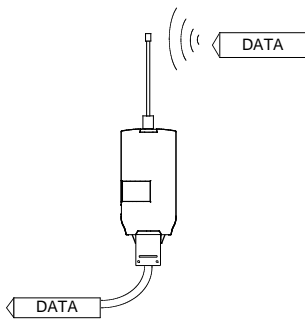

RX-addressing - OFF.

The radio modem will transfer all frames which do not contain an address. Received data is transmitted to the RS-232 interface.

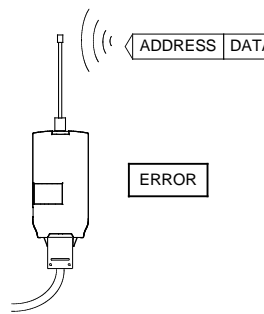

RX-addressing - OFF

The radio modem will not receive any air interface frames containing addresses. Data will not be received

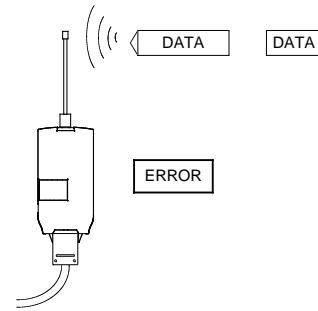

RX-addressing - ON

There is no address in the received radio interface frame. Data will not be received. (The modem will receive only addressed frames).

### 6.2.2 Reading the address from the user protocol

In cases where the modems are used to transfer a protocol that contains addresses or fields that can be considered as addresses the modem can be configured to read the address from the protocol.

This feature can be used to read the address from the protocol, and route the message through repeaters to the intended recipient modem.

In order to work with SATELLINE-1870 the protocol should have the following characteristics:

- Messages are separated by pauses of known minimum length
- The address field of the message is at a known character offset from the first character of the protocol, or the protocol starts with the address.
- The message is a continuous bit stream, the longest possible inter character delay is known.

The SATELLINE-1870 can also be configured to identify protocols which have separate start characters and address offsets for different message types, two sets of parameters are available (protocol-1 and protocol-2). The following table will describe the parameters, which affect the protocol identification.

| PARAMETER                               | FORMAT / LENGHT                                                                                     | DESCRIPTION                                                                                                                                                                                                                                                                                                                                                                                                                                                                                                                                                          |
|-----------------------------------------|-----------------------------------------------------------------------------------------------------|----------------------------------------------------------------------------------------------------------------------------------------------------------------------------------------------------------------------------------------------------------------------------------------------------------------------------------------------------------------------------------------------------------------------------------------------------------------------------------------------------------------------------------------------------------------------|
| Pause length                            | 1-100, equals the time of a transfer frame on RS-232 (start bit, data, parity if enabled, stop bit) | <p>The user protocol should have a break (a pause) in data transmission between messages. The default value for the pause is 3 bytes.</p> <p>NOTE! The pause length also affects the conditions of finding SL command and the conditions of ending the radio transmission.</p> <p>This parameter should be changed to be longer than known worst case inter character delay of the used protocol but shorter than the worst case inter packet delay. For example for MODBUS-RTU this should be set to 3.</p> <p>This parameter is common for both message types.</p> |
| Protocol 1, Address from RS232 protocol | ON/OFF                                                                                              | <p>ON= the modem will use the parameters entered for protocol 1 to find the address from the data on the DTE port.</p> <p>OFF= the modem will not use the parameters for protocol 1.</p>                                                                                                                                                                                                                                                                                                                                                                             |
| Protocol 1, Address from RS232 protocol | ON/OFF                                                                                              | <p>ON= the modem will use the parameters entered for protocol 2 to find the address from the data on the DTE port.</p> <p>OFF= the modem will not use the parameters for protocol 2.</p>                                                                                                                                                                                                                                                                                                                                                                             |
| Start character protocol 1,2            | HEX, 8 bits                                                                                         | <p>The protocol should have a constant start character. Entering HEX 2A (***) as a start character will cause the modem to interpret any character preceded by a "break length" as a start character.</p>                                                                                                                                                                                                                                                                                                                                                            |
| Address offset protocol 1,2             | BCD, 0-15                                                                                           | <p>Defines the distance/offset from the start character to the first byte of the address field.</p> <p>Entering '0' as address offset will cause the modem to use the start character as the first byte of the address field.</p>                                                                                                                                                                                                                                                                                                                                    |
| Length of address field protocol 1,2    | ASCII addresses                                                                                     | <p>Address consists of ASCII numbers of various predefined lengths. The numerical value represented by the ASCII characters is converted to a 16 bit BCD code.</p> <p>The corresponding BCD code should be entered in HEX format into the receiving radio modem as the RX address.</p>                                                                                                                                                                                                                                                                               |
|                                         | 1) 1 BYTE (ASCII)                                                                                   | <p>ASCII "1" is transmitted using TX address 0001h<br/>           ASCII "2" is transmitted using TX address 0002h<br/>           ...<br/>           ASCII "9" is transmitted using TX address 0009h</p>                                                                                                                                                                                                                                                                                                                                                              |
|                                         | 2) 2 BYTE (ASCII)                                                                                   | <p>ASCII "01" is transmitted using TX address 0001h<br/>           ASCII "10" is transmitted using TX address 000Ah<br/>           ASCII "99" is transmitted using TX address 0063h</p>                                                                                                                                                                                                                                                                                                                                                                              |
|                                         | 3) 3 BYTE (ASCII)                                                                                   |                                                                                                                                                                                                                                                                                                                                                                                                                                                                                                                                                                      |
|                                         | 4) 4 BYTE (ASCII)                                                                                   |                                                                                                                                                                                                                                                                                                                                                                                                                                                                                                                                                                      |
|                                         | 5) 5 BYTE (ASCII)                                                                                   |                                                                                                                                                                                                                                                                                                                                                                                                                                                                                                                                                                      |
|                                         | HEX addresses                                                                                       | <p>Addresses consisting of HEX type are the direct inary content of the address field of the user protocol presented in HEX format.</p>                                                                                                                                                                                                                                                                                                                                                                                                                              |
|                                         | 6) 8 BIT (HEX)<br>7) 16 BIT (HEX)                                                                   |                                                                                                                                                                                                                                                                                                                                                                                                                                                                                                                                                                      |

**NOTE!**

When detecting a new message, the modem will first check if the message fulfils the rules of protocol 1, if not, the message is compared to the rules of protocol 2. If the message does not fulfil the rules of either protocol the data will not be transmitted.

The table below will give suggested protocol settings for a few commonly used industrial protocols.

| PROTOCOL                                   | MODBUS-ASCII |       | MODBUS-RTU |     | MBUS, IEC 60870-5-101 |     |
|--------------------------------------------|--------------|-------|------------|-----|-----------------------|-----|
|                                            | M            | S     | M          | S   | M                     | S   |
| M=MASTER, S=SLAVE                          | M            | S     | M          | S   | M                     | S   |
| Pause length                               | 200 *1       | 200*1 | 3          | 3   | 3                     | 3   |
| Protocol 1.<br>Address from RS232 protocol | ON           | OFF   | ON         | OFF | ON                    | OFF |
| Protocol 2.<br>Address from RS232 protocol | OFF          | OFF   | OFF        | OFF | ON                    | OFF |
| RX address                                 | ON           | ON    | ON         | ON  | ON                    | ON  |
| TX address                                 | ON           | ON    | ON         | ON  | ON                    | ON  |
| Protocol 1,<br>start character             | 3A           |       | 2A (HEX)   |     | 68 (HEX)              |     |
| Protocol 1,<br>Address offset              | 1            |       | 0          |     | 5                     |     |
| Protocol 1,<br>Type of address field       | 16-bit       |       | 8-bit      |     | 8-bit                 |     |
| Protocol 2,<br>start character             |              |       |            |     | 10 (HEX)              |     |
| Protocol 2,<br>Address offset              |              |       |            |     | 2                     |     |
| Protocol 2,<br>Type of address field       |              |       | 8-bit      |     | 8-bit                 |     |

NOTE

\*1) The time should be set to be as long as the worst measured inter character delay. If the MODBUS serial stream originates from a PC hardware running ie. MS-Windows, a time of 200ms is recommended.

When using industrial protocols, like the ones listed in the table before, the idea is to configure the modem connected to the master of the bus to fetch the address from the protocol. The slaves usually do not have addresses in their responses, thus the modems connected to the slaves should be configured differently, with all responses directed to the master.

When using this function in conjunction with RX masking medium size star topology networks can be constructed. Contact SATEL technical support in order to get more information. For networks, which have more than one consecutive repeater (repeater chains), additional features have to be used, please consult your local distributor or SATEL technical support for the construction of more complicated network topologies.



### 6.2.3 Hop Count (Time to Live=TTL)

When using addressing the modem always include a hop count field in the radio transmission. The basic idea of the hop count feature is to ensure that a telegram can not end up in an infinite loop. The value of the hop count field is statically set by each transmitting modem (in the programming mode). When a repeater receives a radio transmission it automatically checks the address and the hop count of the telegram. If the address is correct, the message is passed on the DTE and to the transmitting part of the repeater. If the TTL of the received message is 0 or 1, the data will not be repeated. If the received TTL is 2 or greater the data will be repeated. The TTL of the repetition will be the received TTL - 1.

**NOTE!**

The hop count parameter is only used in addressed radio transmissions. If hop count is desired but addresses are not needed, the addressing would have to be turned ON in all modems; RX1 should be set to "FFFF" in all modems. This way hop count is used but addresses are ignored.

An example will demonstrate the operation of the hop count parameter.

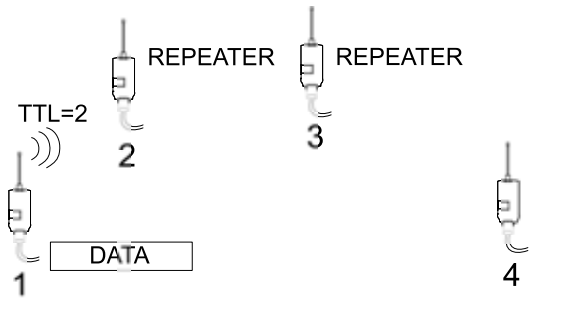
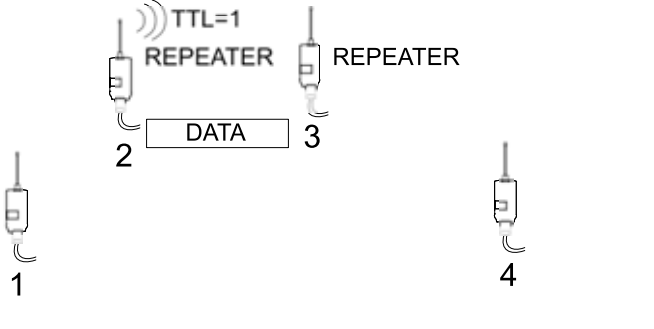
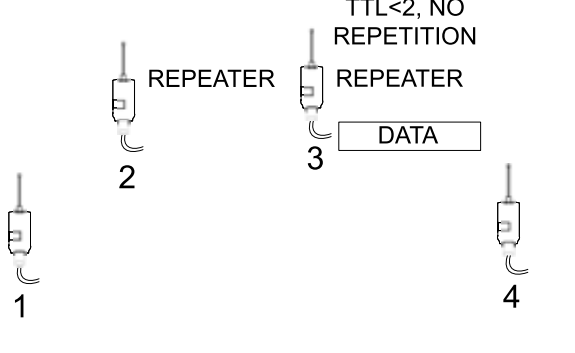
|                                                                                                                                                                                                              |                                                                                                                          |
|--------------------------------------------------------------------------------------------------------------------------------------------------------------------------------------------------------------|--------------------------------------------------------------------------------------------------------------------------|
|                                                                                                                            |                                       |
| <p>Modem 1 has a TTL of 2 or greater. Modem 1 is transmitting.</p>                                                                                                                                           | <p>The Repeater (modem 2) is repeating the received message. The repeat will be transmitted with the original TTL-1.</p> |
|                                                                                                                           |                                                                                                                          |
| <p>The second repeater (modem 3) checks the TTL count from the received message. If the received TTL is &lt;2, the message will not be repeated. The received data will be transmitted to the local DTE.</p> |                                                                                                                          |

#### **6.2.4 Connection between two points**

When forming a connection between two points it is recommended that both the reception and transmission addresses are identical in both radio modems. This is the easiest way to control addresses and the risk caused by interference from other systems operating in the same area is minimal.

**Example:** by setting all addresses of both radio modems to a value '1234', they will accept only those messages which contain this address, and they will use this same value when transmitting data.

If the channel is reserved for use only by a certain network, or if the terminal devices are responsible for addressing, it is not necessary to use addressing in the radio modems.

### **6.3 Using repeaters and addresses in the same system**

In systems with several repeaters, a substation and a base-station, addresses must be used in radio modems. It is possible to realise also a system with only one repeater without addressing. In such a case, the base station will however hear the message both from the substation and from the repeater, in other words the message is duplicated as it moves along the route.

#### **6.3.1 Repeater chain using dual addressing**

If the terminal devices cannot add address chains to the beginning of the data packets, a network with several repeaters may still be realised by using dual addressing.

In dual addressing each link (see arrows in the picture below) is given a unique address, which will prevent duplication of messages and endless loops in the network. The terminal devices need not add anything to the data.

Usually the primary transmit address is used in transmission (TX1). The secondary transmit address (TX2) is used only if the *Repeater Mode* is used and the packet to be repeated was received using the secondary reception address (RX2).

In the following example two repeaters are used. It should be noted that each link (arrow) might be uniquely defined with the help of radio modem numbers and data transfer directions. The *Repeater Mode* should be switched ON only in the radio modems acting as repeaters to prevent the packets from remaining in endless loops in the network.

Repeaters may also act as ordinary substations; in that case the terminal device must wait until the message has reached the end of the repeater chain before sending data.

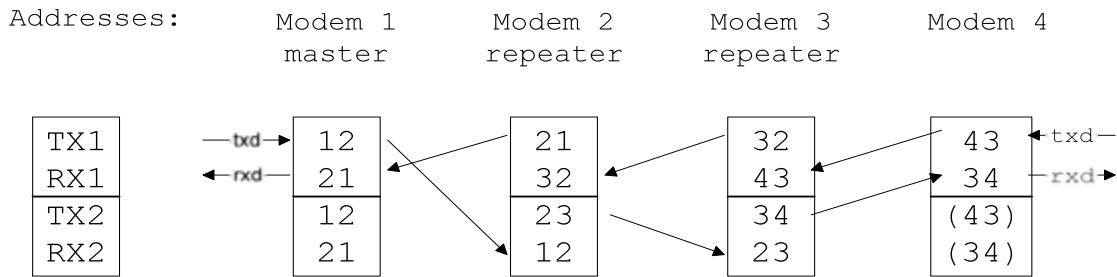

### 6.3.2 Parallel repeater chains using dual addressing

Multiple parallel repeater chains can be created in the same manner as a single repeater chain in the previous chapter. This requires the use of dual addressing and the user must be able to change the primary TX address as follows:

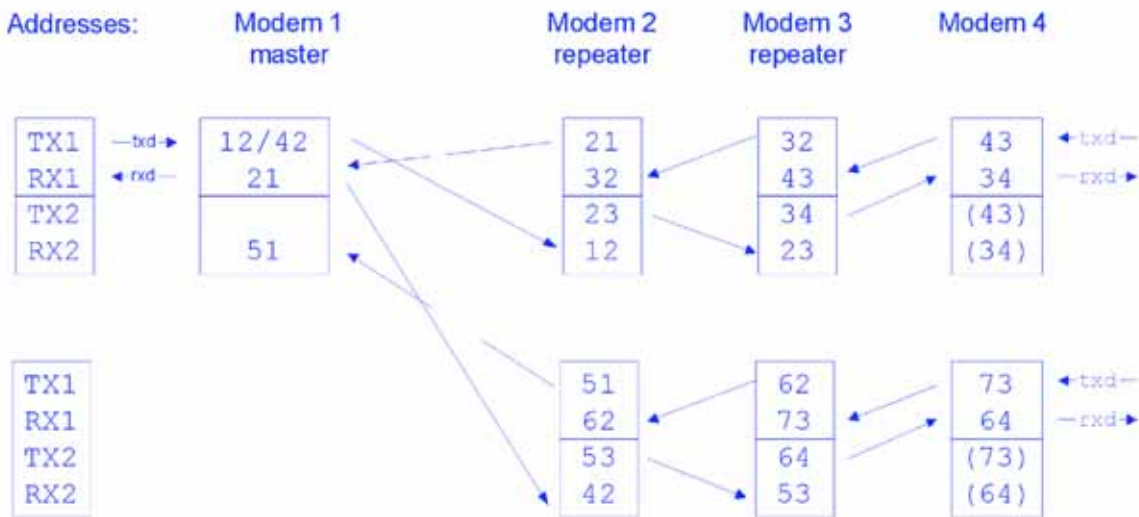

Furthermore, if the user's protocol can distinguish messages originating from various sources (addresses) the above scenario can be extended to more than two chains by programming the master to use "FFFF" as either the primary or the secondary receive address. This will cause the master modem to receive all messages.

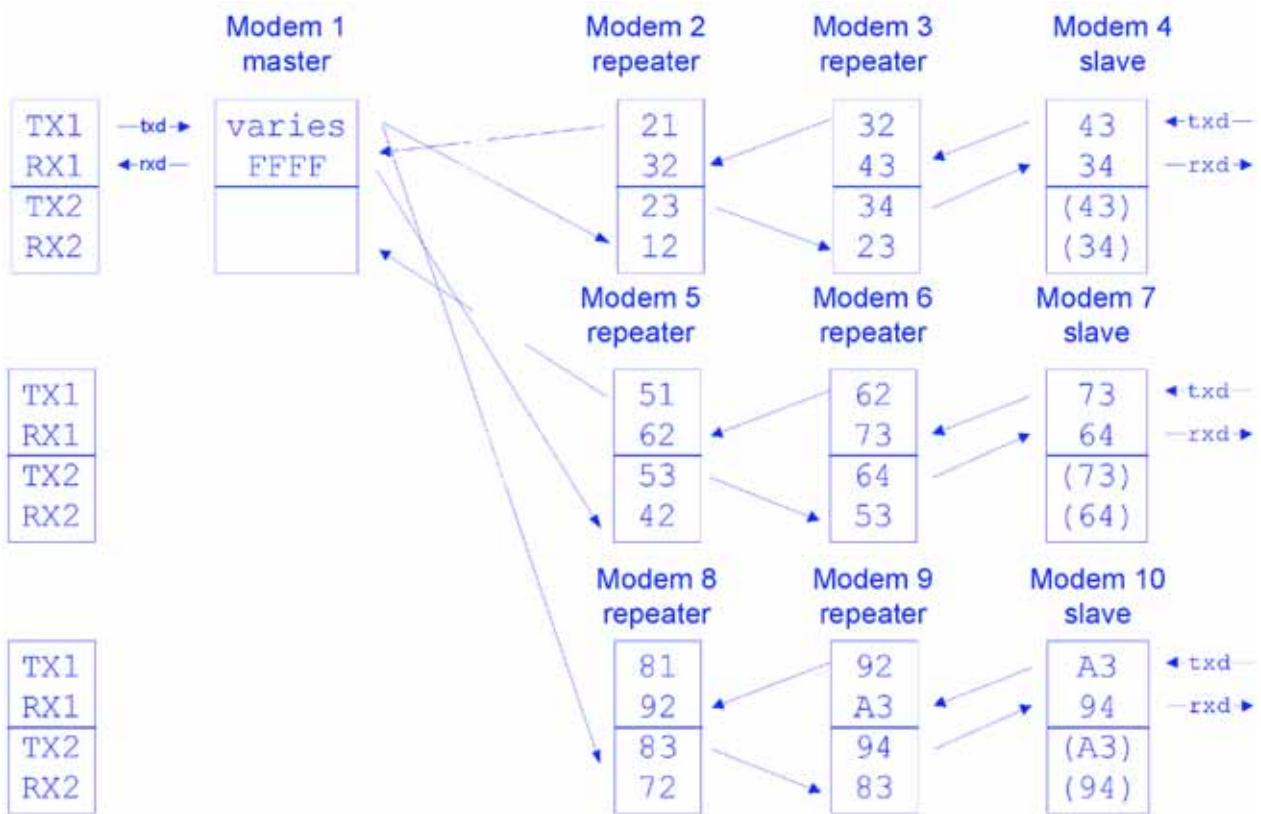

## 7 SETTINGS

The configuration of SATELLINE-1870 radio modems can be easily changed. By connecting pin 7 of the DIN41651-connector to ground (GND) the radio modem will switch to *Programming Mode*. The serial port settings are 9600 bps, N, 8,1 (data transfer speed 9600 bps, no parity, character length 8-bits and one (1) stop bit).

By using SL commands active radio channel and addresses can be changed without switching the radio modem into the *Programming Mode*. Serial port settings will remain as those defined previously when the radio modem was in *Programming Mode*.

### 7.1 Changing parameters using a terminal device

The serial port of the radio modem is connected to a terminal device or a PC, which emulates a terminal (this can be accomplished by using a suitable program such as the *SaTerm 4* program or the Windows™ Hyper Terminal program). Check the wiring of the serial port connection cable. Terminal device serial port settings must be set to 9600 bps, N, 8, 1 (data transfer speed 9600 bps, no parity, data length 8 bits and one (1) stop bit). MODE-pin (pin 7 of the DIN41651-connector of the radio modem) is then connected to ground (GND). Following this the radio modem will transmit the following message to the terminal (certain configuration settings might differ from the ones shown):

```
-----  
***** SATEL, SATELLINE - 1870E *****  
  
SW Version x.y.z HW Version uCTC8L.a0 Serial no. 0123456789  
-----  
Current settings  
-----  
1) Radio frequency      869.4125 MHz, Band 6 (869.4000-869.6500, 500 mW)  
2) Radio settings      TX power 500 mW, RSSI-threshold -113 dBm, TX delay 0 ms  
3) Addressing          RX address OFF/0000/0000, TX address OFF/0000/0000  
                       Protocol 1: OFF, Start char. 00, Offset 0, 1 BYTE  
                       Protocol 2: OFF, Start char. 00, Offset 0, 1 BYTE  
                       Hop-count 15, TX address bitmapping OFF  
                       RX address masking OFF, Repeater address bypassing OFF  
                       Subnet mask 1 0000, Subnet mask 2 0000  
4) Serial port         9600 bit/s, 8 bit data, None parity, 1 stop bit  
                       Pause length 3  
5) Handshaking         CTS Clear to send, RTS Ignored  
6) Additional setup    Repeater OFF, SL ON, Block-CRC OFF, TX priority ON,  
                       Power save OFF, Frame limit OFF, SL Extended OFF  
                       Full frame CRC - OFF  
7) Tests               Test mode Inactive  
8) Restore factory settings  
  
E) EXIT and save settings  
Q) QUIT without saving  
  
Enter selection >
```

### 7.1.1 Changing frequency (active radio channel frequency)

The frequency of the radio is controlled from a sub menu. Press "1" to display the frequency control menu.

```
Enter selection >1

Radio frequency setup
-----
1) Active subband      6 / (869.4000-869.6500)
2) Radio frequency    869.4125 MHz

Enter selection or ESC to previous menu >
```

The frequency is set by first selecting the desired sub-band and then by selecting the desired frequency from that sub-band.

To set the sub-band press "1", a menu will be displayed

Enter selection or ESC to previous menu > 1

```
Enter selection or ESC to previous menu >1
Radio Subband Selection
-----
1) Subband1 ( 868.0000-868.6000 MHz, max power 25 mW )
2) Subband2 ( 868.6000-868.7000 MHz, max power 10 mW )
3) Subband3 ( 868.7000-869.2000 MHz, max power 25 mW )
4) Subband4 ( 869.2500-869.3000 MHz, max power 10 mW )
5) Subband5 ( 869.3000-869.4000 MHz, max power 10 mW )
6) Subband6 ( 869.4000-869.6500 MHz, max power 100 mW )
7) Subband7 ( 869.6500-869.7000 MHz, max power 25 mW )
8) Subband8 ( 869.7000-870.0000 MHz, max power 05 mW )

Enter selection or ESC to previous menu >
```

Choose the desired sub-band by selecting the number in the beginning of the corresponding row, i.e. press "6" to select sub-band no. 6. Once a number is pressed the menu will return to the previous sub-menu.

Now select "2" to enter the desired frequency.

```
Enter selection or ESC to previous menu > 2

Enter selection or ESC to previous menu >2
Radio frequency setup
-----
Active frequency      869.4125 MHz

Enter new frequency (MHz) or ESC to cancel >
```

Enter the new frequency. Be sure that the frequency matches the frequency plan / channel list presented in chapter 1.2.

**NOTE !**

Adjustment of the active radio channel of the radio modem to frequencies other than those allocated and/or allowed by local authorities is strictly forbidden. Use or intended use of forbidden frequencies may lead to prosecution and penalties. SATEL is not responsible for any illegal use practiced with any devices manufactured and/or sold by SATEL and is not liable to pay any damages or compensation caused by such illegal use.

**NOTE !**

The duty cycle of the device is not controlled by the radio modem, the system that operates the modem controls the duty cycle of the modem. Exceeding the duty cycle limits set by authorities is strictly forbidden. Use of duty cycles exceeding the duty cycle limit may lead to prosecution and penalties. SATEL is not responsible for any illegal use practiced with any devices manufactured and/or sold by SATEL and is not liable to pay any damages or compensation caused by such illegal use.

### 7.1.2 Changing radio settings (power and sensitivity)

Radio settings which consist of transmitter output power and receiver sensitivity can be configured by selecting main menu selection "2". In the following example both the transmitter output power (5 mW ... 100 mW) and the receiver sensitivity (-110 dBm ... -45 dBm) are changed. Transmitter output power levels 250 mW and 500 mW also available in 1870E version.

```
Enter selection >2

Radio setup
-----
1) TX power level          10 mW
2) Signal threshold level -113 dBm
3) TX start delay         0 ms

Enter selection or ESC to previous menu >1

TX power setup
-----
1) 5 mW
2) 10 mW
3) 25 mW
4) 50 mW
5) 100 mW

Enter selection or ESC to previous menu > 5
```

|                                                                                                                                                                                        |
|----------------------------------------------------------------------------------------------------------------------------------------------------------------------------------------|
| <pre>Radio setup ----- 1) TX power level           100 mW 2) Signal threshold level  -113 dBm 3) TX start delay          0 ms  Enter selection or ESC to previous menu &gt;2</pre>     |
| <pre>RSSI-threshold level setup (Received Signal Strength Indicator) ----- RSSI-threshold level -113 dBm  Enter new value (-120...-40) or ESC to cancel &gt;-110</pre>                 |
| <pre>Radio setup ----- 1) TX power level           100 mW 2) Signal threshold level  -110 dBm 3) TX start delay          0 ms  Enter selection or ESC to previous menu &gt;3</pre>     |
| <pre>TX Delay Setup ----- TX Delay 0 ms  Enter new value (0...65535) or ESC to previous menu &gt; 100</pre>                                                                            |
| <pre>Radio setup ----- 1) TX power level           100 mW 2) Signal threshold level  -110 dBm 3) TX start delay          100 ms  Enter selection or ESC to previous menu &gt;ESC</pre> |

In environments with high levels of interference and when connection distances are short it is often beneficial to use a "Signal threshold level" value, which is approximately 10 – 20 dBm above the maximum sensitivity level. This will prevent unnecessary receive attempts caused by noise.

**NOTE !**

The setting of the transmitter output power of the radio modem to levels in contradiction with transmitter power levels regulated by local or other governmental authorities is strictly forbidden. Use or intended use of forbidden transmitter power levels may lead to prosecution and penalties. SATEL is not responsible for any illegal use practised with any devices manufactured and/or sold by SATEL and is not liable to pay any damages or compensation caused by such illegal use.



### 7.1.3 Changing addressing

Addressing can be switched ON or OFF with the help of main menu selection "3". In the following example a primary RX-address (transmitter address) is switched ON and the corresponding hexadecimal address value is modified ("0000" -> "0020"). The current values of the parameters are displayed and changed in toggle-type fashion by selecting the appropriate parameter selection number from the list displayed. The next menu level will then enable the modification of the values (within allowed limits). Modification of all other primary and secondary transmitter and receiver addresses is done in similar way.

```

Enter selection >3
-----
Addressing setup
Toggle ON/OFF values. Current value shown
-----
1) RX address                                OFF
2) TX address                                OFF
3) Change primary RX address                 0000
4) Change primary TX address                 0000
5) Change secondary RX address               0000
6) Change secondary TX address               0000
7) protocol 1. Address from RS-232 user protocol OFF
8) protocol 1. Start char.of (HEX 'ASCII')  00 ''
9) protocol 1. Address offset of user protocol 0
A) protocol 1. Type of address field         1 BYTE
B) Hop-count (Time To Live)                  15
C) protocol 2. Address from RS-232 user protocol OFF
D) protocol 2. Start char.of (HEX 'ASCII')  00 ''
E) protocol 2. Address offset of user protocol 0
F) protocol 2. Type of address field         1 BYTE
G) TX address bitmapping                     OFF
H) RX address masking                       OFF
I) Repeater address bypassing               OFF
J) Subnet mask 1                            0000
K) Subnet mask 2                            0000

Enter selection or ESC to previous menu >
-----
Enter selection or ESC to previous menu >1
  
```

```
Addressing setup
Toggle ON/OFF values. Current value shown
-----
1) RX address                                ON
2) TX address                                OFF
3) Change primary RX address                 0000
4) Change primary TX address                 0000
5) Change secondary RX address               0000
6) Change secondary TX address               0000
7) protocol 1. Address from RS-232 user protocol OFF
8) protocol 1. Start char.of (HEX 'ASCII') 00 ''
9) protocol 1. Address offset of user protocol 0
A) protocol 1. Type of address field         1 BYTE
B) Hop-count (Time To Live)                  15
C) protocol 2. Address from RS-232 user protocol OFF
D) protocol 2. Start char.of (HEX 'ASCII') 00 ''
E) protocol 2. Address offset of user protocol 0
F) protocol 2. Type of address field         1 BYTE
G) TX address bitmapping                     OFF
H) RX address masking                       OFF
I) Repeater address bypassing                OFF
J) Subnet mask 1                             0000
K) Subnet mask 2                             0000

Enter selection or ESC to previous menu >
```

```
Enter selection or ESC to previous menu >3
```

```
RX Address Setup
-----
RX Address    0000

Enter new address (HEX) or ESC to cancel >0020
```

The address is given in hexadecimal format with four digits and the number of different addresses is thus over 65 000.

#### 7.1.4 Changing serial port settings

The settings of the serial port can be modified by selecting main menu selection "4" and by then selecting the desired settings. The programming of the serial port parameters is demonstrated below. In the following example the serial port settings are set to 9600 bps, 8 data bits, 1, stop bit, no parity.

```
Enter selection >4
```

```
Serial port 1
Settings
-----
1) Data speed          1200/s
2) Data bits           7 bit data
3) Parity bits         Even parity
4) Stop bits           2 stop bit
5) RS-232 Pause length 3 bytes

Enter selection or ESC to previous menu > 1
```

```
Serial port 1 data speed
-----
1) 300 bit/s
2) 600 bit/s
3) 1200 bit/s
4) 2400 bit/s
5) 4800 bit/s
6) 9600 bit/s
7) 19200 bit/s

Enter selection or ESC to previous menu > 6
```

```
Serial port 1
Settings
-----
1) Data speed          9600 bit/s
2) Data bits           7 bit data
3) Parity bits         Even parity
4) Stop bits           2 stop bit
5) RS-232 Pause length 3 bytes

Enter selection or ESC to previous menu > 2
```

```
Serial port 1 data Bits
-----
1) 7 bit data
2) 8 bit data

Enter selection or ESC to previous menu > 2
```

```
Serial port 1
Settings
-----
1) Data speed          9600 bit/s
2) Data bits           8 bit data
3) Parity bits         Even parity
4) Stop bits           2 stop bit
5) RS-232 Pause length 3 bytes

Enter selection or ESC to previous menu > 3
```

```
Serial port 1 parity bits
-----
1) None parity
2) Even Parity
3) Odd Parity

Enter selection or ESC to previous menu > 1
```

```
Serial port 1
Settings
-----
1) Data speed          9600/s
2) Data bits           8 bit data
3) Parity bits         None parity
4) Stop bits           2 stop bit
5) RS-232 Pause length 3 bytes

Enter selection or ESC to previous menu > 4

Serial port 1 stop bits
-----
1) 1 stop bit
2) 2 stop bits

Enter selection or ESC to previous menu > 1

Serial port 1
Settings
-----
1) Data speed          9600 bit/s
2) Data bits           8 bit data
3) Parity bits         Even parity
4) Stop bits           1 stop bit
5) RS-232 Pause length 3 bytes

Enter selection or ESC to previous menu > 5

RS-232 Pause length
-----
Pause length  3

Enter new value (1 - 255) or ESC to cancel > 10

Serial port 1
Settings
-----
1) Data speed          9600 bit/s
2) Data bits           8 bit data
3) Parity bits         Even parity
4) Stop bits           2 stop bit
5) RS-232 Pause length 10 bytes

Enter selection or ESC to previous menu >
```

The settings of the serial port must be modified to correspond with the settings of the terminal device that is to be connected to the radio modem.

**NOTE!**

It should be noted that switching the radio modem into *Programming Mode* by connecting the PROG-pin (pin 7 of the DIN41651-connector) to ground (GND) will change the settings of serial port to "9600,8,N,1" automatically irrespective of the serial port *data transfer mode* settings.

### 7.1.5 Modification of handshaking functions

Handshaking related configuration settings may be modified by selecting option "5" from the main menu. In the following example characteristics of the CTS-line (CLEAR TO SEND -> TX BUFFER STATE), RTS-line (IGNORED -> FLOW CONTROL) are changed.

```
Enter selection >5
Serial port 1 Handshaking
-----
1) CTS line property  Clear to send
2) RTS line property  Ignored

Enter selection or ESC to previous menu > 1
Select CTS line property
-----
CTS line property
1) Clear to send
2) TX buffer state
3) RSSI threshold
4) Always ON
5) External converter control

Enter selection or ESC to previous menu >2
Serial port 1 Handshaking
-----
1) CTS line property  TX buffer state
2) RTS line property  Flowcontrol

Enter selection or ESC to previous menu >2
Select RTS line property
-----
RTS line property
1) Ignored
2) Flowcontrol
3) Reception control

Enter selection or ESC to previous menu >1
Serial port 1 Handshaking
-----
1) CTS line property  TX buffer state
2) RTS line property  Ignored

Enter selection or ESC to previous menu >
```

### 7.1.6 Special functions

Special functions (additional set-up) are modified by selecting from the main menu selection "6". (For further information please see the Chapters describing the said functions). The current values of the parameters are displayed and can be modified in toggle-type fashion by selecting the appropriate parameter selection number.

```
Enter selection >6
```

```
Additional setup
Toggle ON/OFF values. Current value shown.
-----
1) Repeater                OFF
2) SL-commands             ON
3) Datablock CRC-16 error check OFF
4) Power save              OFF
5) Radio TX priority       ON
6) Limit radio frame length OFF
7) Extended SL commands    OFF
8) Full frame CRC-16 error check OFF

Enter selection or ESC to previous menu >
```

### 7.1.7 Activating tests

Tests can be activated by selecting main menu selection "7". Tests are activated by setting the status of the desired test to "ON" and will remain active until the value of the selection in the menu is returned to the value "OFF".

```
Enter selection >7
```

```
Tests setup
-----
1) Short block test        OFF
2) Long block test         OFF
3) Unmodulated carrier    OFF

Enter selection or ESC to previous menu >
```

### 7.1.8 Restoring factory settings

Factory settings can be restored by selecting option "8" from the main menu.

```
Enter selection >8
```

```
Restore factory settings
-----
Restore factory settings (Y/N)?
```

Restoring is confirmed by pressing "Y" (Y=YES) or cancelled by pressing "N" (N=NO) in the case restoring is not wanted after all. Also the pressing of "ESC" button at any point in the procedure will return the display to the previous (next higher) menu level without restoring factory settings.

### 7.1.10 Saving modified settings into the permanent memory

All modified settings must be saved into the permanent non-volatile memory of the radio modem before exiting the *Programming Mode*. Selecting option "E" from the main menu will cause the settings to be saved:

```
Enter selection >E  
  
Configuration saved!  
Please turn off program mode switch!
```

**NOTE!**  
To switch the radio modem back into DATA mode from the *Programming Mode* the PRG-pin of the DIN41651-connector (pin 7) must be disconnected from ground (GND or SGND).

## 7.2 Changing parameters using the SL-COMMANDS

The controlling terminal device can change the configuration settings of a radio modem. This is accomplished with the help of SL-commands, which can be used during data transfer. SL-commands can be used to change e.g. the frequency or addresses. It is also possible to interrogate a radio modem in order to gain information concerning current settings that are in use. The terminal device is either a PC or a programmable logic (PLC) together with suitable (terminal) program. SL-commands must be enabled using *Programming Mode* before they can be used.

A SL-command is a one continuous string of characters, which is separated from other data by pauses that are at least three (3) characters long. No extra characters are allowed at the end of a SL-command. Serial interface settings are the same as in data transfer and pin 12 of the serial connector MUST NOT be connected to ground (GND). SL-command is properly recognised also in the case when the command string is terminated in <CR> (=ASCII character no. 13, Carriage Return, 0x0d) or <CR><LF> (<LF> = ASCII char. no. 10, Line Feed, 0x0a). If multiple SL-commands are sent to the radio modem the next command can be given after receiving the response ("Ok", the requested value or "Error") of the proceeding command. In addition, it is recommended to implement a timeout to the terminal software for recovering the case when no response is received from the radio modem.

When the power of a radio modem is switched off the configuration settings of a radio modem always return to values defined initially using the *Programming Mode*, thus resetting any settings changed using SL-commands during power on. It is however possible to save settings changed by using SL-commands and to make them the new configuration settings. By default changes made with SL-commands are not saved to the permanent memory to prevent its excessive wear-out.

The radio modem will acknowledge all commands by returning an "OK" (command carried out or accepted) or the requested value, or an "ERROR" (command not carried out or interpreted as erroneous) message.

### 7.2.1 Frequency

| Command       | Effect and description of command                                                                                                 |
|---------------|-----------------------------------------------------------------------------------------------------------------------------------|
| SL&F=nnn.nnnn | Set frequency to nnn.nnnn MHz.                                                                                                    |
| SL&F?         | Display current frequency (response is 'nnn.nnnn MHz').                                                                           |
| SL&B=n        | Select sub-band n.                                                                                                                |
| SL&B?         | Display current sub-band 's lowest- and highest frequencies (response is 'nnn.nnnn MHz, nnn.nnnn MHz').                           |
| SL&+=nn       | Set channel number (channel numbers are associated with the selected sub-band, see chapter 1.2)                                   |
| SL&N?         | Display current channel's number (response is '+nn').<br>Numbering starts 12.5 kHz from the sub-band lower limit, see chapter 1.2 |

Please note that when changing the sub-band the modem will also adjust the power level and the frequency so that they comply with the limits of the selected sub-band. The modem automatically sets the frequency to the lowest possible frequency within the selected sub-band (Channel no. 1.)

### 7.2.2 Extended SL commands

The SL command response might sometimes be hard to find among data received from the modem. To make the parsing of SL command responses easier Extended SL commands have been created. Setting the extend SL command ON encapsulates the SL command response with a <STX>SL:'response'<ETX><LF>.

Extended SL commands can be turned on from the programming menu or by using a SL command.

### 7.2.3 Addressing

| Command                  | Effect and description of command                                                                |
|--------------------------|--------------------------------------------------------------------------------------------------|
| SL#I=xxxx                | Set all addresses (RX1, RX2, TX1, TX2) to value xxxx, ie. SL#I=0F0F                              |
| SL#I?                    | Display both primary addresses (TX1, RX1), (response 'xxxx:xxxx')                                |
| SL#T=xxxx                | Set both transmit addresses (TX1, TX2) to value xxxx                                             |
| SL#T?                    | Display primary transmit address (TX1), (response 'xxxx')                                        |
| SL#R=xxxx                | Set both receive addresses (RX1, RX2) to value xxxx                                              |
| SL#R?                    | Display primary receive address (RX1), (response 'xxxx')                                         |
| SL#A=xxxx,xxxx,xxxx,xxxx | Set all addresses in the following order: RX1, RX2, TX1, TX2                                     |
| SL#A?                    | Display all addresses in the following order: RX1, RX2, TX1, TX2<br>(response 'xxxx,xxxx,xxxx'). |

xxxx = address in hexadecimal format (0000 ... FFFF)

Entering 0000 for a received address will cause the modem to disregard the address. In this case the modem will receive all *addressed* transmission with *ANY* address. For further information, please see chapter "6.2. Addressing".



### 7.2.4 Radio parameters

| Command    | Effect and description of command                                                                                                                                                                                                                                     |
|------------|-----------------------------------------------------------------------------------------------------------------------------------------------------------------------------------------------------------------------------------------------------------------------|
| SL@R?      | Display field strength measured during last message frame. (response is '-xxx dBm'). The measured value is cleared 10s after reception has ended. After the clear timeout, the response will be -255 dBm to indicate that no valid measurement has been done for 10s. |
| SL@F?      | Displays the field strength of the carrier present when the RSSI was last measured. A SL@F? query sent to the modem when the modem is transmitting will result in an answer -255 dBm to indicate that the measurement can not be completed at the given time.         |
| SL@P=xxxxx | Set the RF-output power, where xxxxx is the decimal value of the intended power in milliwatts. If the given value does not correspond to one of the programmed power levels, the output power is rounded to the nearest possible value.                               |
| SL@P?      | Display the RF output power (response is 'xxx mW').                                                                                                                                                                                                                   |
| SL@T=-xxx  | Set the minimum power level of the signal to be received (= "Signal Threshold level), where xxx is a decimal value of the new intended level in dBm. The range on the RSSI value is -120 dBm to -40                                                                   |
| SL@T?      | Display the current "Signal Threshold Level" (response is '-x(xx) dBm').                                                                                                                                                                                              |

Note that when changing sub-bands the power level is adjusted so that it does not violate the maximum output power for the selected sub-band. If the modem has lower power level, because of a sub-band change, it will remain unchanged even if the sub-band change would be reversed.

## 7.2.5 Other functions

| Command | Effect and description of command                                                                                                                                                                                                                                                                                                                                                                                                                                                                                                                                                                                                                                                                                                                                                                                                                                                                                                                                                                                                                                                                                                 |
|---------|-----------------------------------------------------------------------------------------------------------------------------------------------------------------------------------------------------------------------------------------------------------------------------------------------------------------------------------------------------------------------------------------------------------------------------------------------------------------------------------------------------------------------------------------------------------------------------------------------------------------------------------------------------------------------------------------------------------------------------------------------------------------------------------------------------------------------------------------------------------------------------------------------------------------------------------------------------------------------------------------------------------------------------------------------------------------------------------------------------------------------------------|
| SL**>   | Save current settings as permanent settings                                                                                                                                                                                                                                                                                                                                                                                                                                                                                                                                                                                                                                                                                                                                                                                                                                                                                                                                                                                                                                                                                       |
| SL%V?   | Show software revision information (response is 'Vn.nn')                                                                                                                                                                                                                                                                                                                                                                                                                                                                                                                                                                                                                                                                                                                                                                                                                                                                                                                                                                                                                                                                          |
| SL%N?   | Shows the device serial number. (response i.e. '0123456789')                                                                                                                                                                                                                                                                                                                                                                                                                                                                                                                                                                                                                                                                                                                                                                                                                                                                                                                                                                                                                                                                      |
| SL%S?   | Shows the device software version (response i.e. '2.04')                                                                                                                                                                                                                                                                                                                                                                                                                                                                                                                                                                                                                                                                                                                                                                                                                                                                                                                                                                                                                                                                          |
| SL%H?   | Shows the device HW version (response is i.e. uctc8L.c0')                                                                                                                                                                                                                                                                                                                                                                                                                                                                                                                                                                                                                                                                                                                                                                                                                                                                                                                                                                                                                                                                         |
| SL%D?   | Shows the device family name (response is one of the following: 'SATELLINE, 1870', 'SATELLINE, 1870-OEM', 'SATELLINE, 1870E' or 'SATELLINE, 1870E-OEM',                                                                                                                                                                                                                                                                                                                                                                                                                                                                                                                                                                                                                                                                                                                                                                                                                                                                                                                                                                           |
| SL%P=1  | <p>Sets the modem into the configuration/programming mode. Can be viewed as a virtual grounding of the MODE pin.</p> <p>The menu can be accessed using this command.</p> <p>To return to normal modem operation, choose either Save and Exit or Quit. The new settings (if changed and saved) enter into force when the modem restarts after saving the settings.</p> <p>When exiting or quitting the modem will restart with the saved settings (Save/Exit) or with the settings it had last time it started (Quit). Any changes made using SL commands prior to entering the programming mode that are not saved using the SL** commands are not saved.</p> <p>The serial parameters that are used when entering the SL%P=1 command are used also in the configuration / programming mode.</p> <p>When entering the programming menu using this command, there is a timeout of approx. 1 minute, after which the programming mode will be terminated. This is to ensure that accidental entry of this modem will not jam the modem indefinitely.</p> <p>This function can only be used if extended SL commands are enabled.</p> |
| SL%E=n  | <p>N=1, extended SL commands ON. All return messages responding to SL commands are capsulated &lt;STX&gt;SL"response"&lt;ETX&gt;&lt;LF&gt;</p> <p>N=0, extended SL commands OFF: SL command returns are not capsulated.</p> <p>Some SL command i.e SL%P works only if extended SL commands are ON.</p>                                                                                                                                                                                                                                                                                                                                                                                                                                                                                                                                                                                                                                                                                                                                                                                                                            |
| SL%E?   | Shows the status of the "Extended SL commands" setting, responses are "ON" or "OFF"                                                                                                                                                                                                                                                                                                                                                                                                                                                                                                                                                                                                                                                                                                                                                                                                                                                                                                                                                                                                                                               |
| SL+T=n  | <p>N=1, carrier test is ON</p> <p>N=0, carrier test is OFF</p> <p>Requires "Extended SL commands – ON".</p>                                                                                                                                                                                                                                                                                                                                                                                                                                                                                                                                                                                                                                                                                                                                                                                                                                                                                                                                                                                                                       |

## 8 POWER SUPPLY

The allowed operating voltage is 8 - 30 Vdc. The pin 1 of the DIN41651-16-connector is connected to the positive power supply line. Negative power supply line (ground) is connected to pin 2 of the DIN41651-16-connector. The DTR-line of the radio modem which is connected to pin 14 can be used as an ON/STANDBY –switch, by which the radio modem can be switched either ON (operational state) or OFF (STANDBY).

Connecting the DTR to ground will set the modem to the STANDBY-state. Leaving the DTR unconnected will turn on the modem (internal pull-up).

Especially in applications, where the radio modem is used as a portable device (battery operated applications), the DTR-line (pin 14) should be connected to a logical state "0" whenever it is possible to conserve battery power and prolong operational time between battery charging.

## 9 ACCESSORIES AND ADDITIONAL EQUIPMENTS

### 9.1 RS Cables

| Type     | Description                                                         | Length | Note                          |
|----------|---------------------------------------------------------------------|--------|-------------------------------|
| CRS-18F  | Interface cable DIN41650-16 / D9 f                                  | 1.5 m  | Including power supply cables |
| CRS-18IF | Interface cable DIN41650-16 / D15 f<br>from 1870 to I- or C-LINK100 | 0.4 m  | -                             |

Note! In the description, m= male, f=female connector type.

### 9.2 RF Cables

| Type       | Description                       | Length | Note             |
|------------|-----------------------------------|--------|------------------|
| CRF-1, SMA | Cable with SMA m/TNC f-connectors | 1 m    | RG58 (3 dB/10 m) |
| CRF-5, SMA | Cable with SMA m/TNC f-connectors | 5 m    | RG58 (3 dB/10 m) |

Note! In the description, m= male, f=female connector type.

### 9.3 Antenna

| Type         | Description       |
|--------------|-------------------|
| ANTENNA 1870 | Half-wave antenna |

### 9.4 Additional equipments

| Type                | Description                                                   |
|---------------------|---------------------------------------------------------------|
| SATEL I-LINK 100    | 4 digital I/O-ports with built-in relays and 2 analogue ports |
| SATEL I-LINK 100 MB | Same as I-LINK 100, but with Modbus compatibility             |
| SATEL I-LINK 200    | Extension unit with 4 digital I/O-ports and 2 analogue ports  |
| SATEL I-LINK 300    | Extension unit with 6 digital I/O-ports                       |
| SATEL C-LINK 100    | 4 digital I/O-ports with built-in relays and pulse counter    |
| SATEL C-LINK 100 MB | Same as C-LINK 100, but with Modbus compatibility             |
| SATEL MINI-LINK     | 2 digital I/O-ports with built-in relays and pulse counter    |
| SATEL MINI-LINK MB  | Same as MINI-LINK, but with Modbus compatibility              |
| SATEL RS-LINK 100   | RS-232 to RS-485 / 422 serial converter                       |

## APPENDIX A

| ASCII CHARACTER TABLE |    |    |    |    |   |     |    |   |     |    |   |     |    |   |     |    |   |
|-----------------------|----|----|----|----|---|-----|----|---|-----|----|---|-----|----|---|-----|----|---|
| D                     | H  | A  | D  | H  | A | D   | H  | A | D   | H  | A | D   | H  | A | D   | H  | A |
| 0                     | 0  |    | 43 | 2B | + | 86  | 56 | V | 129 | 81 |   | 172 | AC |   | 215 | D7 |   |
| 1                     | 1  |    | 44 | 2C | , | 87  | 57 | W | 130 | 82 |   | 173 | AD |   | 216 | D8 |   |
| 2                     | 2  |    | 45 | 2D | - | 88  | 58 | X | 131 | 83 |   | 174 | AE |   | 217 | D9 |   |
| 3                     | 3  |    | 46 | 2E | . | 89  | 59 | Y | 132 | 84 |   | 175 | AF |   | 218 | DA |   |
| 4                     | 4  |    | 47 | 2F | / | 90  | 5A | Z | 133 | 85 |   | 176 | B0 |   | 219 | DB |   |
| 5                     | 5  |    | 48 | 30 | 0 | 91  | 5B | [ | 134 | 86 |   | 177 | B1 |   | 220 | DC |   |
| 6                     | 6  |    | 49 | 31 | 1 | 92  | 5C | \ | 135 | 87 |   | 178 | B2 |   | 221 | DD |   |
| 7                     | 7  |    | 50 | 32 | 2 | 93  | 5D | ] | 136 | 88 |   | 179 | B3 |   | 222 | DE |   |
| 8                     | 8  |    | 51 | 33 | 3 | 94  | 5E | ^ | 137 | 89 |   | 180 | B4 |   | 223 | DF |   |
| 9                     | 9  |    | 52 | 34 | 4 | 95  | 5F | _ | 138 | 8A |   | 181 | B5 |   | 224 | E0 |   |
| 10                    | A  |    | 53 | 35 | 5 | 96  | 60 | ` | 139 | 8B |   | 182 | B6 |   | 225 | E1 |   |
| 11                    | B  |    | 54 | 36 | 6 | 97  | 61 | a | 140 | 8C |   | 183 | B7 |   | 226 | E2 |   |
| 12                    | C  |    | 55 | 37 | 7 | 98  | 62 | b | 141 | 8D |   | 184 | B8 |   | 227 | E3 |   |
| 13                    | D  |    | 56 | 38 | 8 | 99  | 63 | c | 142 | 8E |   | 185 | B9 |   | 228 | E4 |   |
| 14                    | E  |    | 57 | 39 | 9 | 100 | 64 | d | 143 | 8F |   | 186 | BA |   | 229 | E5 |   |
| 15                    | F  |    | 58 | 3A | : | 101 | 65 | e | 144 | 90 |   | 187 | BB |   | 230 | E6 |   |
| 16                    | 10 |    | 59 | 3B | ; | 102 | 66 | f | 145 | 91 |   | 188 | BC |   | 231 | E7 |   |
| 17                    | 11 |    | 60 | 3C | < | 103 | 67 | g | 146 | 92 |   | 189 | BD |   | 232 | E8 |   |
| 18                    | 12 |    | 61 | 3D | = | 104 | 68 | h | 147 | 93 |   | 190 | BE |   | 233 | E9 |   |
| 19                    | 13 |    | 62 | 3E | > | 105 | 69 | i | 148 | 94 |   | 191 | BF |   | 234 | EA |   |
| 20                    | 14 |    | 63 | 3F | ? | 106 | 6A | j | 149 | 95 |   | 192 | C0 |   | 235 | EB |   |
| 21                    | 15 |    | 64 | 40 | @ | 107 | 6B | k | 150 | 96 |   | 193 | C1 |   | 236 | EC |   |
| 22                    | 16 |    | 65 | 41 | A | 108 | 6C | l | 151 | 97 |   | 194 | C2 |   | 237 | ED |   |
| 23                    | 17 |    | 66 | 42 | B | 109 | 6D | m | 152 | 98 |   | 195 | C3 |   | 238 | EE |   |
| 24                    | 18 |    | 67 | 43 | C | 110 | 6E | n | 153 | 99 |   | 196 | C4 |   | 239 | EF |   |
| 25                    | 19 |    | 68 | 44 | D | 111 | 6F | o | 154 | 9A |   | 197 | C5 |   | 240 | F0 |   |
| 26                    | 1A |    | 69 | 45 | E | 112 | 70 | p | 155 | 9B |   | 198 | C6 |   | 241 | F1 |   |
| 27                    | 1B |    | 70 | 46 | F | 113 | 71 | q | 156 | 9C |   | 199 | C7 |   | 242 | F2 |   |
| 28                    | 1C |    | 71 | 47 | G | 114 | 72 | r | 157 | 9D |   | 200 | C8 |   | 243 | F3 |   |
| 29                    | 1D |    | 72 | 48 | H | 115 | 73 | s | 158 | 9E |   | 201 | C9 |   | 244 | F4 |   |
| 30                    | 1E |    | 73 | 49 | I | 116 | 74 | t | 159 | 9F |   | 202 | CA |   | 245 | F5 |   |
| 31                    | 1F |    | 74 | 4A | J | 117 | 75 | u | 160 | A0 |   | 203 | CB |   | 246 | F6 |   |
| 32                    | 20 |    | 75 | 4B | K | 118 | 76 | v | 161 | A1 |   | 204 | CC |   | 247 | F7 |   |
| 33                    | 21 | !  | 76 | 4C | L | 119 | 77 | w | 162 | A2 |   | 205 | CD |   | 248 | F8 |   |
| 34                    | 22 | "  | 77 | 4D | M | 120 | 78 | x | 163 | A3 |   | 206 | CE |   | 249 | F9 |   |
| 35                    | 23 | #  | 78 | 4E | N | 121 | 79 | y | 164 | A4 |   | 207 | CF |   | 250 | FA |   |
| 36                    | 24 | \$ | 79 | 4F | O | 122 | 7A | z | 165 | A5 |   | 208 | D0 |   | 251 | FB |   |
| 37                    | 25 | %  | 80 | 50 | P | 123 | 7B | { | 166 | A6 |   | 209 | D1 |   | 252 | FC |   |
| 38                    | 26 | &  | 81 | 51 | Q | 124 | 7C |   | 167 | A7 |   | 210 | D2 |   | 253 | FD |   |
| 39                    | 27 | '  | 82 | 52 | R | 125 | 7D | } | 168 | A8 |   | 211 | D3 |   | 254 | FE |   |
| 40                    | 28 | (  | 83 | 53 | S | 126 | 7E | ~ | 169 | A9 |   | 212 | D4 |   | 255 | FF |   |
| 41                    | 29 | )  | 84 | 54 | T | 127 | 7F |   | 170 | AA |   | 213 | D5 |   |     |    |   |
| 42                    | 2A | *  | 85 | 55 | U | 128 | 80 |   | 171 | AB |   | 214 | D6 |   |     |    |   |