













ANTENNAS | XPOL-1-5G SERIES

X-POLARISED, OMNI-DIRECTIONAL, LTE MIMO ANTENNA

698 - 3800 MHz, 3 dBi



						
698 – 960 MHz; 1710 -2700 MHz; 3400–3800 MHz	3 dBi	Increase x Mb/s	Omni- Directional	Machine to Machine	4G LTE	5G Ready
						
Chemical Protection	IP 65	-40°C to +80°C	Fire Resistant	2X2 MIMO or 4X4 MIMO	CBRS Band	

APPLICATION AREAS



- **Exceptional performance over the main 4G/5G bands**
- **High gain for the antenna size**
- **Wideband 2X2 or 4X4 MIMO 4G/5G antenna**
- **Backwards compatible 2G/3G/4G/LTE antenna (5G Ready)**
- **Weather, dust and vandal resistant enclosure (IP 65)**

Product Overview

The XPOL-1-5G is Poynting's second generation "V2" of this very popular Cross Polarised (XPOL), cellular band, 2x2 MIMO antenna. The addition of a 4X4 MIMO derivative is also available for user specific needs. The antenna has been completely redesigned from the previous generation with an all new enclosure and antenna design. The antenna now includes the newer 3400 - 3800 MHz bands as well as the in demand lower 698 MHz band, which were not previously covered by our V1 and is suitable for 2G, 3G, 4G & 5G. This antenna performs exceptionally well in the following frequency bands: 698 – 960 MHz, 1700 –2700 MHz & 3400 – 3800 MHz, with a peak gain of 3 dBi across the frequency bands of operation.

The radiation patterns of this antenna are omni-directional and exceptionally well controlled, further adding to the performance of the antenna. This makes the antenna perfect for most application areas, such as urban, rural, agricultural and commercial, to achieve the best possible coverage over a large area. The robust mechanical enclosure design makes the antenna weather, dust and vandal resistant and gives it an IP65 rating, suitable for harsh environments.

Features

- New 3400 to 3800MHz, 5G band
- Broadband, including the latest 3.5GHz bands
- X-Polarised 2x2 or 4X4 MIMO Antenna
- Wall or pole mountable
- Lightweight & Rugged
- Weatherproof (IP65)
- High pattern consistency across bands for 4G/5G carrier aggregation

Application Areas

- Outdoor antenna for Fixed Wireless Access (FWA)
- Consumer LTE/5G internet connectivity
- Industrial & Commercial LTE/5G deployments
- Urban and household reception enhancement
- Agricultural & Farming LTE/5G data distribution
- Power, Energy & Water telemetry access
- Oil & Gas communication systems
- Municipal & Government systems
- Repeaters & coverage enhancement amplifiers



Frequency Bands

The XPOL-1-5G is an LTE MIMO antenna that works from 698 – 960 MHz | 1710 -2700 MHz | 3400–3800 MHz

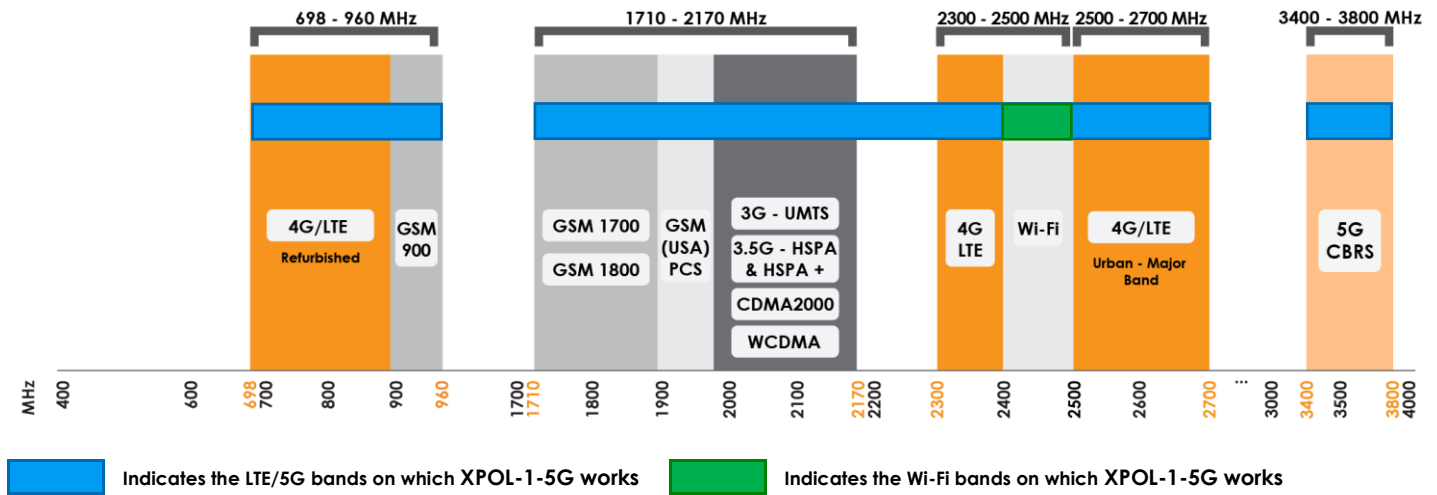

Antenna Derivatives

Product Order Code (SKU)	A-XPOL-0001-V2-21	A-XPOL-0001-V2-41
Ports	2	4
SISO / MIMO	2x2 MIMO	4x4 MIMO
Coax Cable Type	HDF 195	HDF 195
Coax Cable Length	5m	5m
Connector Type	SMA (M)	SMA (M)
Product Weight	0.95 kg	1.240 kg
Packaged Weight	1.05 kg	1.340 kg
EAN	6009710920763	6009710920886

*The coax cable & connector are factory mounted to the antenna

Electrical Specifications

Frequency bands:	698 – 960 MHz 1710 -2700 MHz 3400–3800 MHz
Gain (max):	3 dBi
VSWR:	≤2.5:1
Feed power handling:	20 W
Input impedance:	50 Ohm (nominal)
Polarisation:	Cross Polarised
Coax cable loss:	0.385 dB/m @ 900 MHz 0.565 dB/m @ 1800 MHz 0.666 dB/m @ 2400 MHz 0.788 dB/m @ 3000 MHz
DC short:	Yes, path to ground

Product Box Contents

Antenna:	A-XPOL-0001-V2
Mounting bracket:	Pole and wall mount

Mechanical Specifications

Product dimensions	247 mm x 157 mm x 88 mm
Packaged dimensions:	270 mm x 190 mm x 100 mm
Radome material:	UV Stable ASA
Radome colour:	Brilliant White Pantone P 179-1 C
Mounting Type:	Wall, pole, and window mount

Environmental Specifications, Certification & Approvals

Wind Survival:	≤250 km/h <small>*Except for window mount configuration</small>
Temperature Range (Operating):	-40°C to +70°C
Environmental Conditions:	Outdoor/Indoor
Water ingress protection ratio/standard:	IP 65
Salt Spray:	MIL-STD 810G/ASTM B117
Operating Relative Humidity:	Up to 98%
Storage Humidity:	5% to 95% - non-condensing
Storage Temperature:	-40°C to +70°C
Enclosure Flammability Rating:	UL 94-HB
Impact resistance:	IK 10
Product Safety & Environmental:	Complies with CE and RoHS Standards



Antenna Performance Plots

VSWR

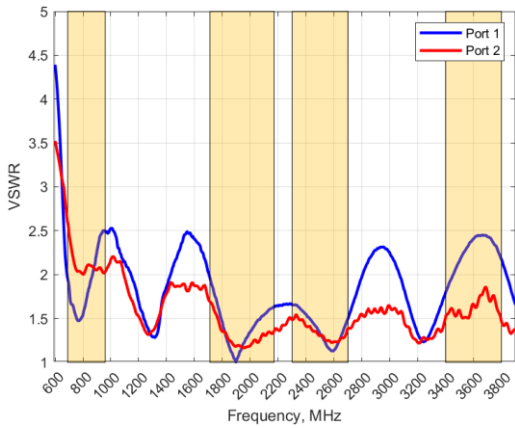

GAIN (EXCLUDING CABLE LOSS)

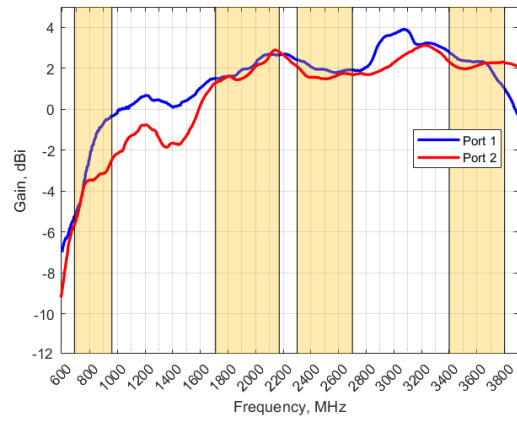

Voltage Standing Wave Ratio (VSWR)

VSWR is a measure of how efficiently radio-frequency power is transmitted from a power source, through a transmission line, into a load. In an ideal system, 100% of the energy is transmitted which corresponds to a VSWR of 1:1.

The XPOL-1-5G delivers superior performance across all bands with a VSWR of $\leq 2.5:1$.

Gain* in dBi

3 dBi is the peak gain across all bands from 698 – 3800 MHz

**Antenna gain measured with polarisation aligned standard antenna*

Technical Drawings

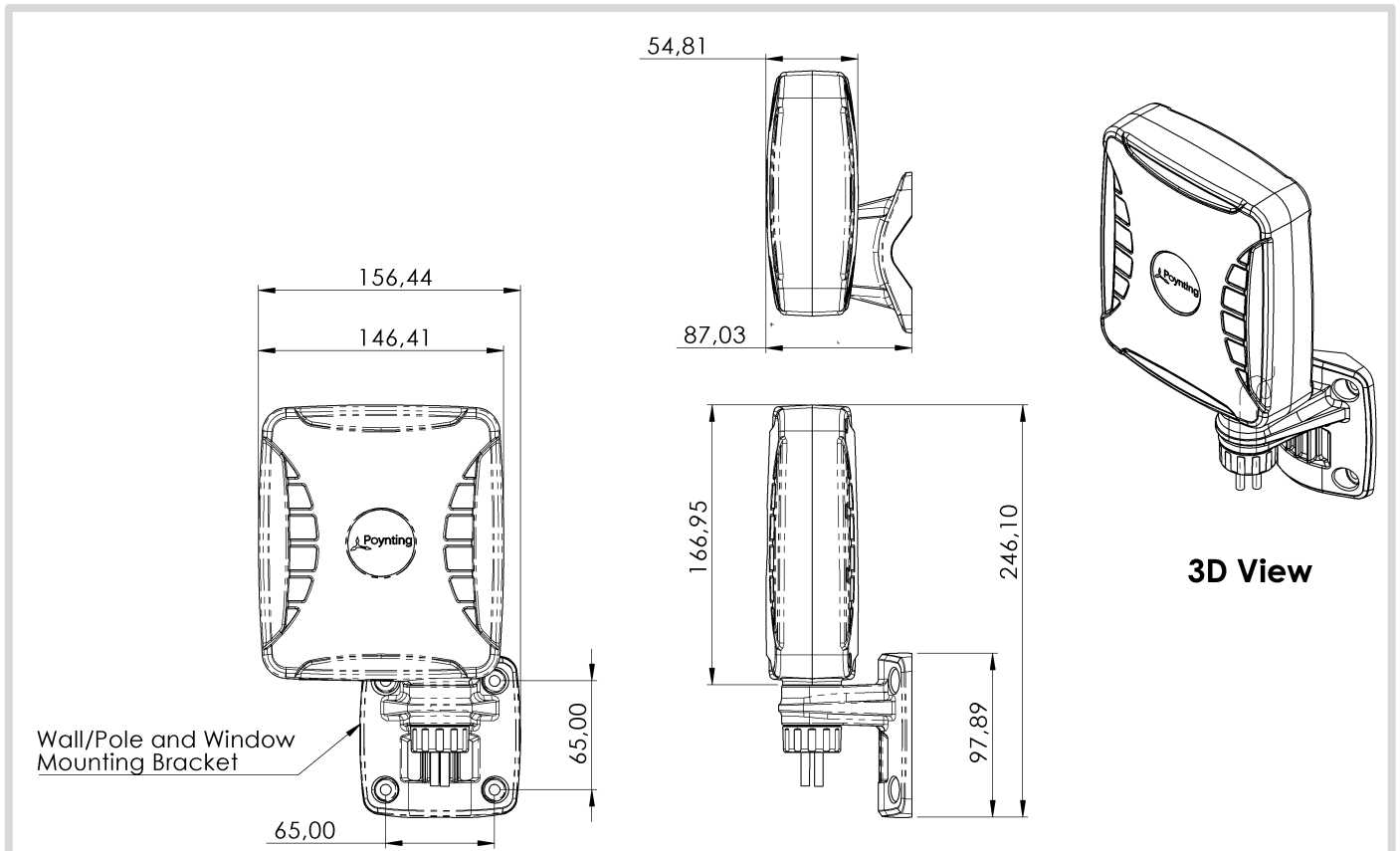

Radiation Patterns

Azimuth: 698 – 960 MHz

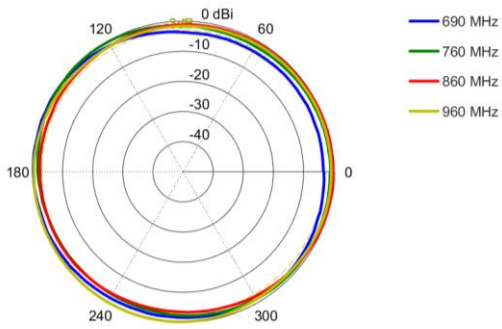

Azimuth: 1710–2170 MHz

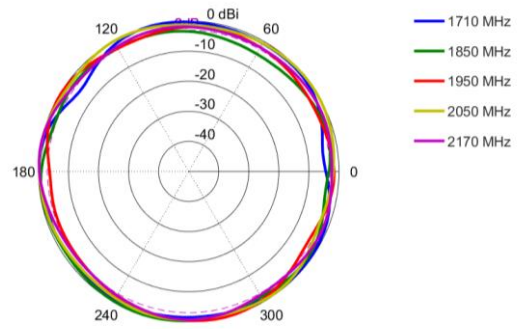

Azimuth: 2170–2700 MHz

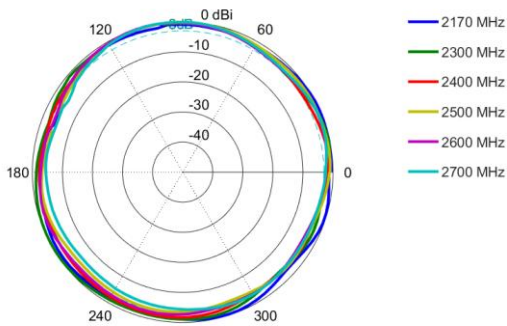

Azimuth: 3400–3800 MHz

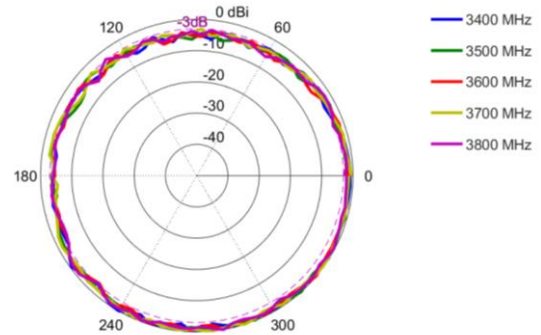

Elevation: 698–960 MHz

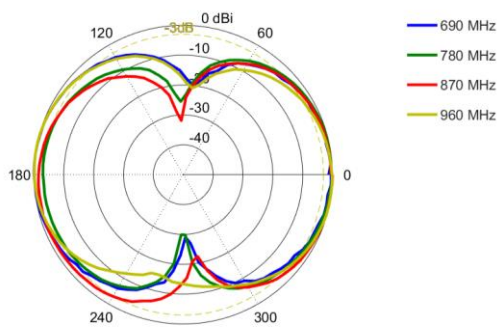

Elevation: 1710–2170 MHz

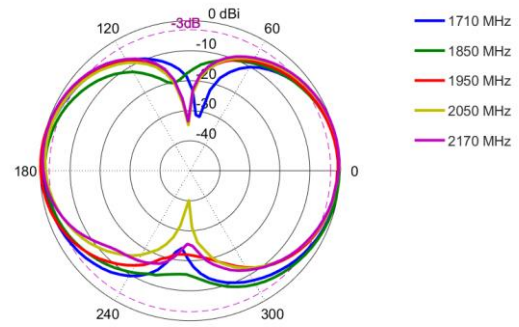

Elevation: 1710 -2700 MHz

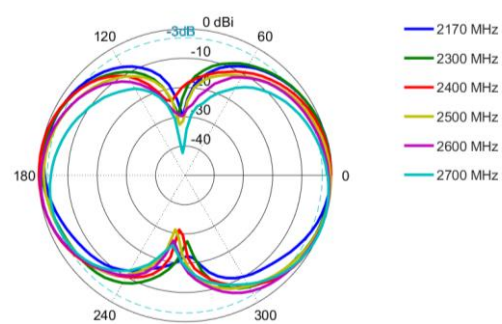

Elevation: 3400–3800 MHz

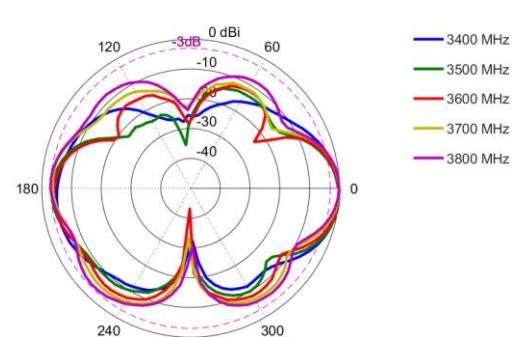

Mounting Options

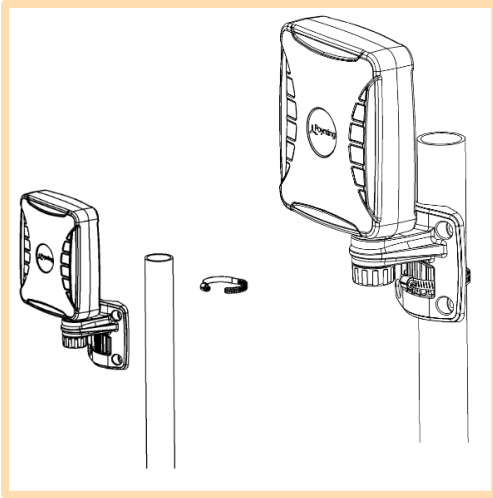

Pole Mount

Pole/Wall mounting bracket used with pipe clamp (included)

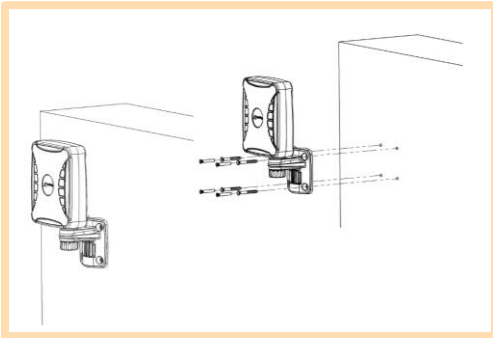

Wall Mount

Pole/Wall mounting bracket using knock-in screws (included)

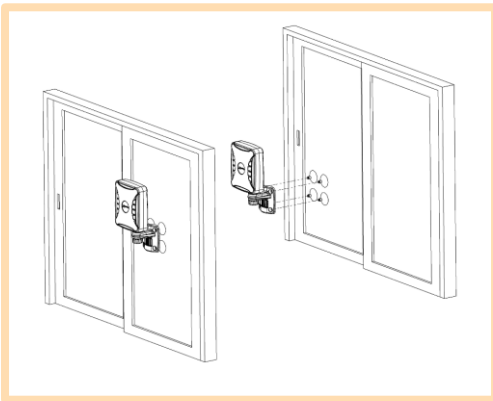

Window Mount

Pole/Wall mounting bracket used with window suckers (included)

Additional Accessories

Extension Cables: Up to 10m HDF 195
Various connectors available
Installation poles and brackets available

See accessories technical specifications on www.poynting.tech

Contact Poynting

Poynting Antennas (Pty) Ltd - Head Office

Unit 4, N1 Industrial Park
Landmarks Avenue,
Samrand, 0157
South Africa

Phone: +27 (0) 12 657 0050

E-mail: sales@poynting.co.za

Poynting Europe

Regus Business Center Neue Messe Riem
Kronstadter Straße 4
81677 München
Germany

Phone: +49 89 208026538

E-mail: sales-europe@poynting.tech