

DATASHEET

Type	Wireless Antenna
Frequencies	WIFI / BLUETOOTH (2.4 GHz) WIFI (5.0 GHz) WIFI (5.9 GHz)
Mounting	Mast Mount
Part No.	2JWIFI12
Revision	00





Content

1. SPECIFICATION.....	2
1.1. Electrical Specifications	2
1.2. Connection Specifications	2
1.3. Mechanical Specifications and Dimensions	3
1.3.1. Mast Mount.....	3
2. MEASUREMENT	4
3. IMAGES	5

1. SPECIFICATION

1.1. Electrical Specifications

Frequencies	WIFI / BLUETOOTH (2.4 GHz) WIFI (5.0 GHz) WIFI (5.9 GHz)
Impedance	50 Ohms
Gain	12 dBi
VSWR	<2:1
Beamwidth (horizontal)	40°
Beamwidth (vertical)	30°
Operating temperature	-40°C to +85°C

1.2. Connection Specifications

Connector:	N-Type female
Extension lead length:	Upon request
Cable type:	RG58
Suitable connectors:	SMA RP male nickel

1.3. Mechanical Specifications and Dimensions

1.3.1. Mast Mount

Material: Lid: ABS / Base: Metal
Max. dimensions: 10.4cm x 17.4cm x 10.4cm (H x L x W)
Weight: 454 g 'without extension cable'
Colour: Black (for different colours please ask our sales team)

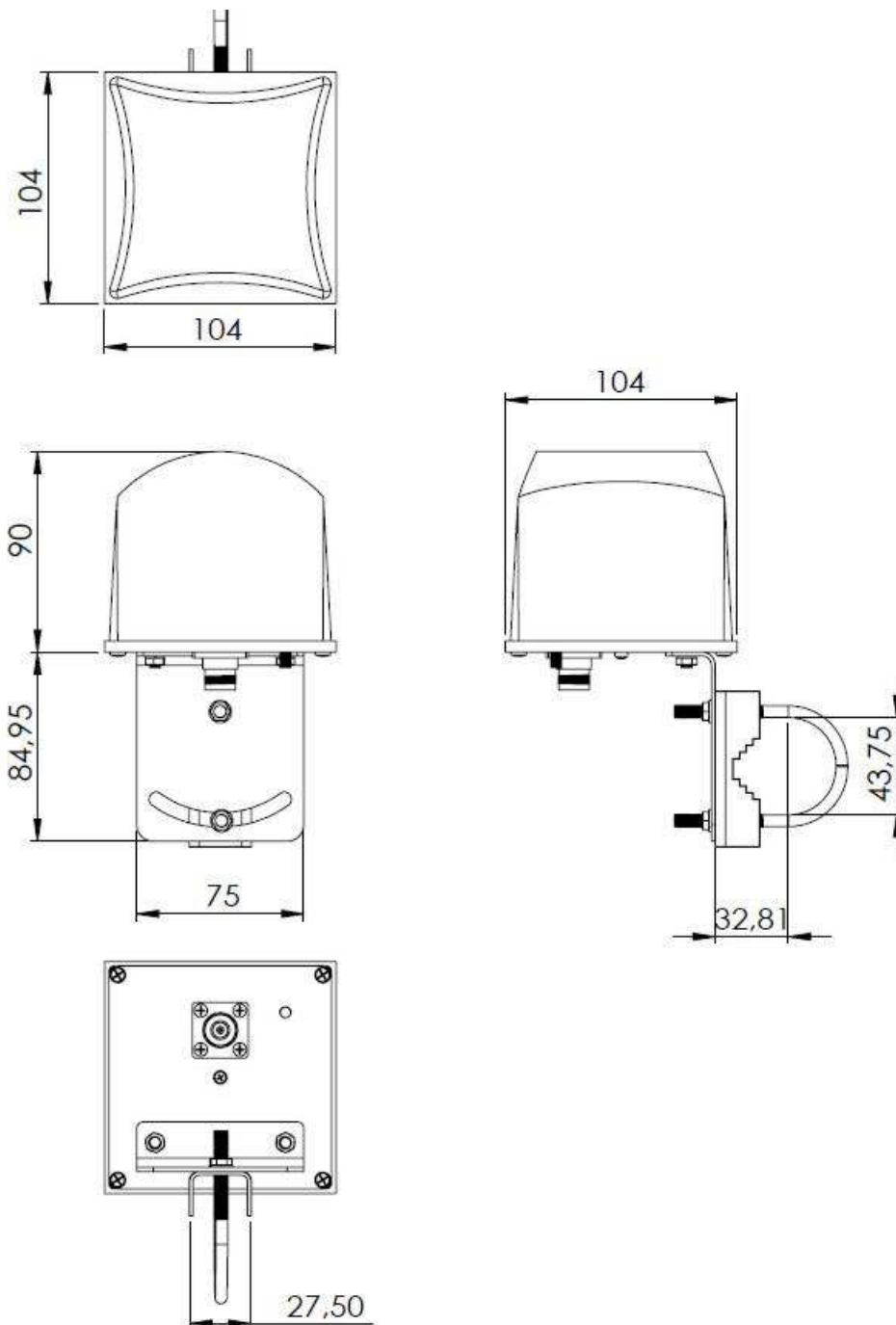



2. MEASUREMENT

Log Mag (WiFi)

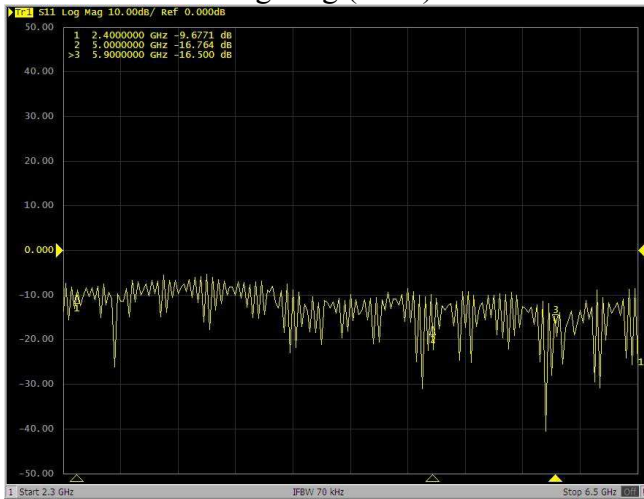

Tested with 2m cable length

Log Mag (WiFi)

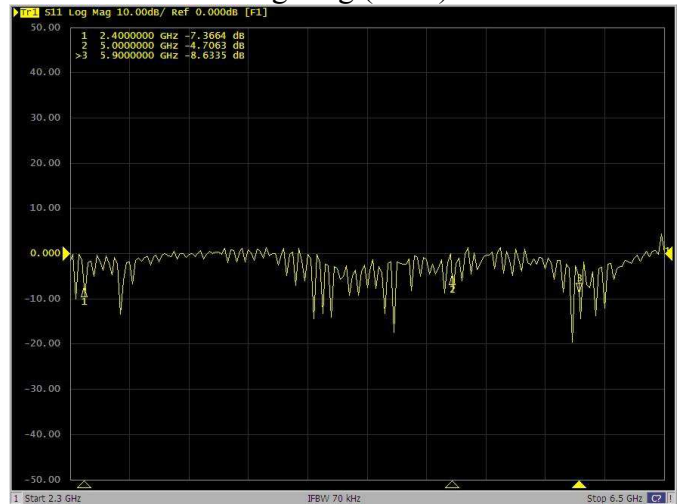

No cable used, measured on end of the connector

LOG MAG (WiFi 2.4GHz)

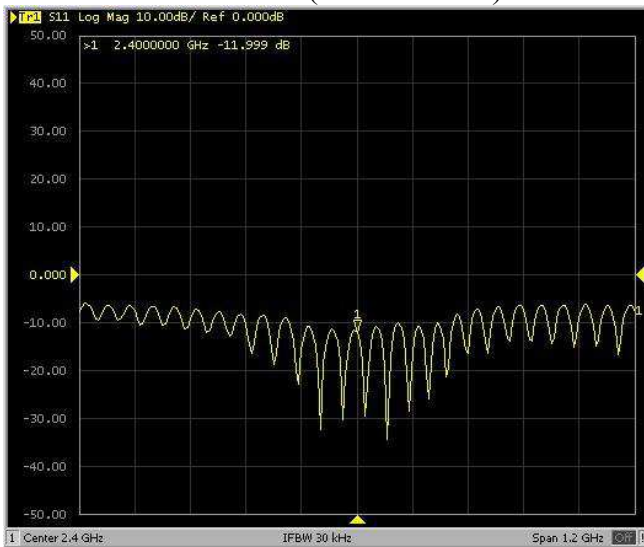

Tested with 2m cable length

Log Mag (WiFi 2.4GHz)

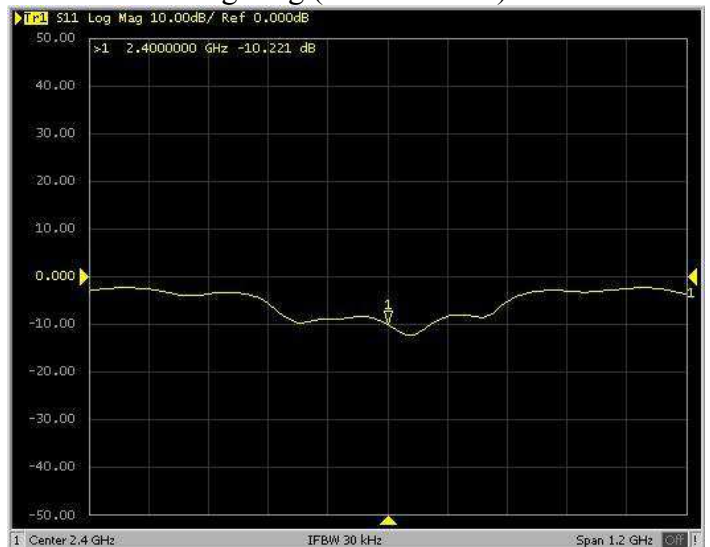

Tested with 40cm cable length



3. IMAGES

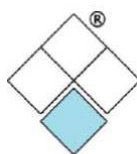
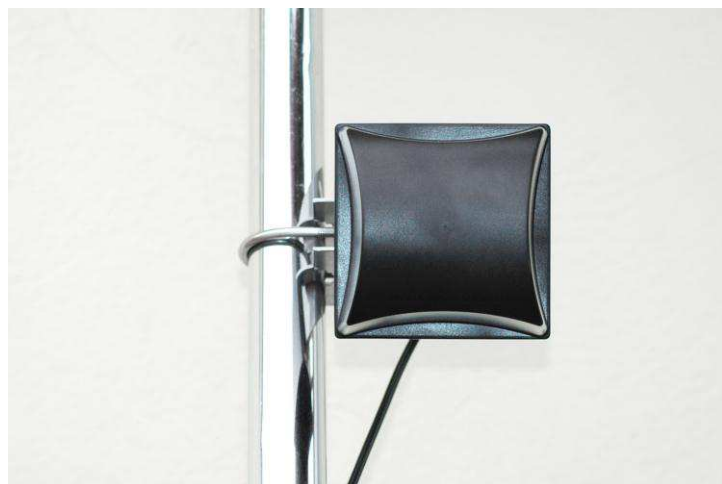

SARTELCO® SISTEMI SRL

Via Torri Bianche, 1
20871 Vimercate (MB)

Tel. +39- 039- 62905.1 Fax. +39- 039- 62905.99
e-mail sistemi@sartelco.it Web www.sartelco.it